

hydrolink

NUMBER 3/2020

IAHR 85 ANNIVERSARY

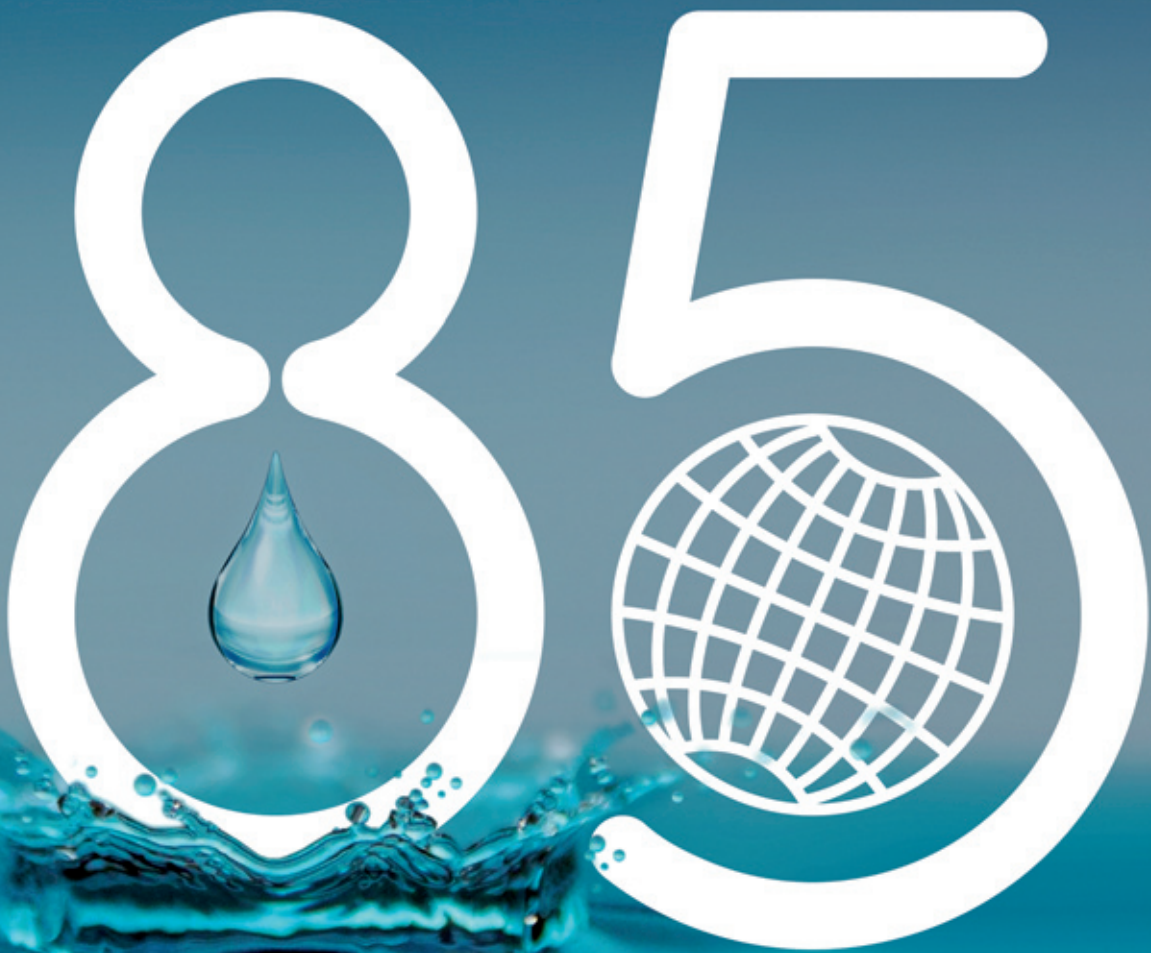

International Association
for Hydro-Environment
Engineering and Research

Hosted by
Spain Water and IWHR, China

IAHR HISTORY 1935 – 2020

SEE PAGE 68

**WOMEN IN THE IAHR LEADERSHIP
SHARE THEIR THOUGHTS**

SEE PAGE 74

**HYDRO-ENVIRONMENTAL
EDUCATION IN AFRICA**

SEE PAGE 81

MESSAGE FROM THE PRESIDENT

It has been said that an anniversary gives a community certainty that achievements can defy mortality. In its 85 years of history, IAHR has made great contributions to the development of water engineering and the protection of the environment. IAHR is a community of scholars, including researchers and practitioners, in different fields of hydro-environmental research and practice- a truly international organization that produces high quality knowledge products that lead the industry. Our IAHR monographs have been defining the frontiers of research and practice in environmental fluid mechanics, hydraulic structures, and water quality control, to mention but a few. Many of our institute members have provided the scientific and engineering knowhow to support sustainable development of many countries. As the reminiscences in this issue will show, IAHR is a treasured international name brand.



IAHR President
Professor Joseph Hun-wei Lee
The Hong Kong University
of Science and Technology

My first encounter with IAHR dates back to September 1983 when I attended the 20th IAHR Congress in Moscow. It was a memorable occasion as I met so many leading experts – at a time when the use of turbulence modeling in hydraulics was in its infancy. I was captivated by the depth and lively intellectual exchanges at the Congress – which also offered to every participant a much sought-after ticket to the Bolshoi Ballet. I also recall that during the dinner banquet – I was politely requested by Jean Cunge – a father figure of computational hydraulics - to dance on his behalf with a Russian lady engineer before he would answer my scientific questions! IAHR has always had this unique family spirit that ties young members to more experienced mentors – which continues to this day.

Water and the environment rank high on the policy agenda of most governments. Climate change, population growth and urbanization give rise to many water, energy and food security issues. The “Second Machine Age” is also bringing many opportunities for developing smart solutions for water resilience. Nature-based solutions to many hydro-environmental challenges will offer a continuing stimulus to exciting developments at the interface of ecology, hydraulics, hydrology, and system science – besides job opportunities for young engineers and researchers. In order to advance our scientific core, we need to create platforms for inter-disciplinary research that capture the synergy across the traditional boundaries of our Technical Committees. In order to stay relevant in the age of globalization we need to continue our bold steps towards enhancing diversity and our engagement in the international policy dialogue.

The IAHR Council has developed a new Strategic Plan 2020-2023 which embraces three core agenda items: (i) increase global presence; (ii) inspire, disseminate and catalyze state of the art knowledge; and (iii) promote diversity and enhance international collaboration. The Executive Committee has been working hard to implement the

Strategic Plan. I would like to outline some of the happenings and my views on the future development of IAHR.

- 1) *Eco-hydraulics*: Led by Vice-President Rob Ettema we are conducting a critical review of the IAHR publication portfolio – galvanizing the efforts of members to support the development of our journals and rejuvenate the production of state-of-the-art technical monographs that are highly valued by the profession. We will be putting in resources to uplift the next stage development of the *Journal of Eco-hydraulics* – to capture the rich opportunities offered by inter-disciplinary research in this domain.
- 2) *Artificial Intelligence (AI) and Water*: AI and Robotics have been transforming work and the way we do things. While leading IT giants and technology entrepreneurs have all expressed interests in water, the impact of AI on hydro-environment research and practice is just in its infancy. We will engage noteworthy partners and industrial sponsors to enhance our development and presence in this domain. For example, many members have been working on smart urban water supply systems to address global issues of water security. But there is so much more to be done at the R&D level, and there is no doubt that AI will offer many opportunities for innovation and entrepreneurship to our young members in the future.
- 3) *Engagement with Africa*: We are developing action plans to drastically enhance our engagement with Africa on water issues. In this effort I am supported by three IAHR “African Ambassadors” and colleagues who are sharing their insights on what IAHR can do to contribute to the sustainable development of the world’s second most populous continent - and one with a growing global stature.

Every crisis brings about opportunities. We are making good progress on many fronts. First, we have set up a new Membership Committee under VP Silke Wiepricht, who is developing new initiatives to enhance member benefits and diversity and increase membership. Second, VP Hyseop Woo is leading a new Task Force on Institutional Advancement to engage new and existing Institutional Members and Sponsors – with promising results. Finally, the Secretariat, under Executive Director Tom Soo, has successfully revamped our IT system - we are now in an excellent position to mount online events in ways previously unimaginable. On 21 March 2020, IAHR organized for the first time an online World Water Day forum on “Hydro-Environment Engineering and Adaptation to Climate Change” that was live streamed to an audience of over 10,000! A webinar on “The Business of Global Water Security: Linking Knowledge to Practice”, spearheaded by past president Roger Falconer on 10 September 2020 was highly successful, as is the case with an online YPN lecture held in July 2020 on how to write scientific papers by JHR Editor Mohamed Ghidaoui.

An anniversary is a time for reflection. In our reflection, there is not only a sense of pride in what we have achieved but also a renewed determination to innovate to bring IAHR to greater heights. I would like to acknowledge with deep appreciation the staunch support of our two hosting organizations: Spain Water (CEDEX, DGA and DGC) in Madrid and IWHR in Beijing. I would also like to express my sincere gratitude to Honorary Member Dr Angelos Findikakis and the Secretariat for their excellent work in the preparation of this memorable issue. ■



NUMBER 3/2020

IN THIS ISSUE

IAHR International Association for Hydro-Environment Engineering and Research

IAHR Secretariat

Madrid Office
IAHR Secretariat
Paseo Bajo Virgen del Puerto 3
28005 Madrid SPAIN
tel + 34 91 335 79 08
fax + 34 91 335 79 35

Beijing Office
IAHR Secretariat
A-1 Fuxing Road, Haidian District
100038 Beijing CHINA
tel +86 10 6878 1808
fax +86 10 6878 1890

iahr@iahr.org
www.iahr.org

Editor:
Angelos Findikakis
Bechtel, USA
anfindik@bechtel.com

Editorial Assistant:
Estibaliz Serrano
IAHR Publications Manager
publications@iahr.org

Technical Editors:
Joe Shuttleworth
Cardiff University

Sean Mulligan
National University
of Ireland Galway

Hydrolink Advisory Board

Luis Balairon • CEDEX –Ministry Public Works, Spain
Jean Paul Chabard • EDF Research & Development, France

Yoshiaki Kuriyama • The Port and Airport Research Institute, PARI, Japan

Jaap C.J. Kwadijk • Deltares, The Netherlands
Henrik Madsen • DHI, Denmark

Rafaela Matos • Laboratório Nacional de Engenharia Civil, Portugal

Yasuo Nihei • Tokyo University of Science, Japan

Jing Peng • China Institute of Water Resources and Hydropower Research, China

Patrick Sauvagat • Artelia Eau & Environnement, France

James Sutherland • HR Wallingford, UK

Karla González Novion • Instituto Nacional de Hidráulica, Chile

ISSN 1388-3445

Cover picture: @IAHR2020

Message from the President 66

IAHR History 1935 – 2020: 85 years 68

IAHR achievements through recent past presidencies 71

Some thoughts by IAHR Secretary Generals 72

Women in the IAHR leadership share their thoughts 74

Young Professionals Networks' perspectives 78

Hydro-environmental education in Africa 81

Encouraging closer connectivity between IAHR and Africa 83

Innovative solutions and new tools for fish-friendly hydropower 86

Minimizing the required surge vessel volume by an improved thermodynamic model 90

CEDEX studies to improve the safety of the Ebro Dam 92

39th IAHR World Congress, Granada, Spain 95



International Association
for Hydro-Environment
Engineering and Research

Hosted by
Spain Water and IWHR, China

A BRIEF REFLECTION ON THE HISTORY OF IAHR

BY HELMUT KOBUS

IAHR is celebrating its 85th anniversary – a good reason to reflect on our present role as a global association and about our activities and goals for the future, and also to take a brief look back at the frame of our history.

IAHR was founded in 1935. In the same year the construction of Hoover Dam in USA was finished, the largest scale hydraulic structure of its time, for providing water and hydroelectric power to the region. And also in 1935 the first modern aeroplane DC3 started a completely new era of long-distance- travelling, a necessary prerequisite for our 38 IAHR World Congresses.

The book “History of Hydraulics” (Hunter Rouse and Simon Ince, 1957) documents the general situation of water research and engineering in the first half of the last century. And on the occasion of the 50th anniversary of IAHR in 1985 the book “Hydraulics and Hydraulic Research, a Historical Review” (G.Garbrecht, Ed.) was published.

In 1898 the first hydraulics laboratory was established in Dresden, Germany, and subsequently numerous hydraulics institutes were founded in Europe and USA. However, a wide gap between academic doctrine and engineering practice was indicated for the use of hydraulic models to study hydrodynamic phenomena. Therefore, the founders of IAHR had the intention to advance the international cooperation both in hydromechanics research and its application to hydraulic engineering.

The following reflection shortly outlines the main developments of IAHR and its role in science and engineering in a rapidly changing world full of challenges for our profession.

Start and consolidation: 1935 - 1960

On 3 September 1935, the “International Association for Hydraulic Structures Research” was founded in Brussels, Belgium, by 63 directors of hydraulic laboratories (55 from Europe, 8 from USA). Official languages were German, French and English. The first IAHR Congress was held in 1937 in Berlin, but in 1939 World War II suddenly interrupted all connections until 1945. IAHR resumed its activities in 1948 with its second congress in Stockholm. There the word “structures” was dropped from the name in order to indicate the much broader scope of IAHR, the “International Association of Hydraulic Research”, maintaining English and French languages until about 1990 and then reducing to English as the only official language of IAHR. As Hans-Albert Einstein once said: “the universal language of science is broken English”.

IAHR started with member Institutes as well as individual membership – a wise and far sighted decision for the continuous growth of our association. The secretariat of IAHR was hosted by Delft Hydraulics with its director serving simultaneously as Secretary General – a fortunate arrangement for IAHR that lasted for 65 years.

Our profession deals with water and all its uses e.g. for water supply and irrigation and as a medium for transport and for energy production, with a long historical tradition. The science of fluid - and hydromechanics has progressed rapidly for many engineering

applications such as hydropower, navigation or aeronautics. However, in hydraulic engineering the natural water bodies are usually not suitable for direct applications of analytical approaches (geometry of rivers or coasts, sediment problems, variable hydrology). As H.J. Schoemaker put it: “Water engineering is empirism with a gradual and critical absorption of science”.

The first 25 years of IAHR were marked by a systematic consolidation of the art and a perpetual struggle with the theoretical structuring of the many phenomena our profession has to deal with in our environment.

Expansion and Globalization: 1960 – 1985

My first contacts with IAHR I had through Hunter Rouse, the director of the Iowa Institute of Hydraulic Research (IIHR). After graduation in Civil Engineering in Stuttgart, I was graduate student in hydromechanics at IIHR from 1961 until 1965. Under the leadership of Hunter Rouse and his team I graduated with a doctoral thesis in ship hydrodynamics and enjoyed the inspiring atmosphere among an international group of doctoral students from all parts of the world. Hunter Rouse, our highly admired teacher, was a global player and a convincing promoter of IAHR, and following his advice most of us joined IAHR.

At this time, our profession experienced rapid developments in hydraulic research for turbulent flows, in laboratory and field measurement techniques and in hydraulic modelling. With the development of digital computers numerical calculations were also advancing rapidly. And in engineering applications, problems of sediment transport, mixing processes and water quality problems required increasing attention.

In response to these developments, IAHR started its “Journal of Hydraulic Research” as an international publication platform for the water sciences. This journal has soon become an outstanding quality mark of the association and a prime option for publishing research results in hydraulics for a global readership. The editorial boards have permanently done and continue to do an outstanding job in maintaining the Journal’s mission as flagship of IAHR. And in the meantime we also have the International Journal of River Basin Management, the Journal of Ecohydraulics, and the Journal of Hydroinformatics (published by IWA).

IAHR has established specialized technical sections in order to give ample attention to rapidly developing new branches by means of symposia and reports or guidelines and short courses. The numerous sections were scheduled in 1970 into Division I Hydromechanics (6 technical sections) and Division II Hydro-Environment (by now 9 technical sections, 3 of them as joint committees with IWA) followed by Division III Innovation and Professional Development IPD (2 committees). My personal engagement in IAHR started in the Committee on Fluid Mechanics.

After my return to Germany I worked at the “Versuchsanstalt für Wasserbau und Schiffbau” in Berlin West (in the times when there existed two German states), held a visiting appointment at Caltech, USA and joined the University of Karlsruhe (by now KIT). There I worked with Eduard Naudascher and Erich Plate, who both had graduated in Germany and then started their careers in USA and were keen supporters of IAHR. With Erich Plate we organized the IAHR 1977 Congress in Baden-Baden with the support of all West German Hydraulics Institutes (sharing the risk of a potential financial deficit). The Congress turned out to be a big success both for IAHR and also for the German hydraulics community with the consequence of many permanent cooperations.

As an example for the globalization process in these times, I want to mention just one particular step. In 1984, we organized an IAHR symposium on “Scale effects in modelling hydraulic structures” in Germany with participants from 40 nations. However, so far participation in IAHR from China was exclusively from Taiwan and Hong Kong, although mainland China had many big hydraulic engineering projects on the agenda. In the preparation phase we learned – with the help of IAHR honorary member Ben Yen – the political reason for this and could finally manage to bring several representatives of Chinese hydraulics institutes to the symposium to presented their laboratories and their projects. This door-opening event had the result that IAHR since that time has experienced an increasing participation and support from China.

The rapid advances in science have led to a significant broadening of the research activities of IAHR, but the focus on science was also connected to some extent with a reduction of the involvement of practicing engineers, since the direct link to hydraulic engineering was not always adequately considered. The interaction between consulting engineers, governmental representatives and researchers showed a widening gap for some time.

Broadening the scope: 1985 – 2010

The membership of IAHR has grown from about 1000 in 1960 to about 2000 members from all continents in 1985. The rapid developments in research, many international engineering projects, and increasing internationalization of educational efforts have been driving forces, and after the turn of the century we have crossed the 4000 members line and presently move towards 5000.

The rapid developments of hydrosience and proliferation of research activities, which is reflected in the structure of the Technical Divisions

and the growing number of sections, required strategic considerations by the IAHR Committee on Future Directions and Initiatives, which produced guidelines for the profile of IAHR in 1995 followed by an IAHR Strategic Plan 2005 -2009. The policy paper promoted several main thrusts:

- Efforts to bridge the gap between research and application with inclusion of professional issues and engineering practice in its broadest sense into the IAHR spectrum of activities.
- The broadening of the scope of IAHR activities towards water resources management, including ecological, economic and societal aspects.
- Involvement in continuing education and professional development.
- Initiation and support of regional and local activities.

In consequent pursuit of these goals, the name of IAHR has been changed from “Hydraulic Research” into “Hydraulic Engineering and Research” in 1999 and finally into “International Association of Hydro-Environment Engineering and Research”.

The UNESCO/IAHR panel report “Education of Hydraulic Engineers” triggered the establishment of a new section on Continuing Education and Professional Development. And as a step from policy towards implementation, in 1999 a network of European universities collaborated in a “European Engineering Graduate School Environment Water (IAHR-EGW)”. This ultimately was also a reason to form a European Division of IAHR.

In Stuttgart we started an international bilingual M.Sc.program WAREM (Water Resources Engineering and Management) in 1997, and a bilingual doctoral program ENWAT (Environment Water), which finds worldwide interest and response. The first IAHR Student Chapter started here in 1999 (by now IAHR YPN BW). The formation of student chapters was considered the best way to involve the young generation, and soon many universities followed the example. And all these local chapters were finally called “Young Professionals Network” (YPN) – by now there exist more than 50 YPNs in IAHR.

With the development of fast computers, computational hydraulics took off in the 1970s, with rapid advances in numerical modelling of hydrosystems and for hydroenvironmental impact assessment studies. And since 1989 the developments in “Hydroinformatics” have opened totally new possibilities for our profession. From now on the combination of laboratory models and numerical models together with field data provided good options for the solution of complex engineering tasks. And hydroinformatics for water and environment



1993 Tokyo Congress - President Carstens and Vice President Kobus.

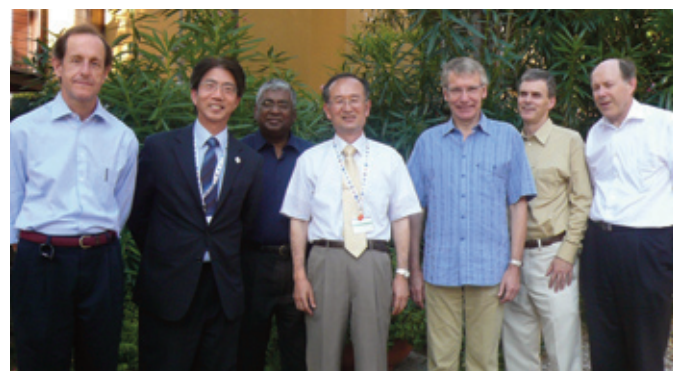

2007 Executive Committee Members: (from left to right) Ramon Gutierrez Serret, Joseph H. Lee, Etienne Mansard, Nobuyuki Tamai, Gerhard Jirka, Peter Goodwin and Christopher George.

also provided new opportunities for interdisciplinary collaboration with geology for groundwater problems or with biochemistry for water quality problems and for ecohydraulics.

I have been involved in the continuous enlargement of the scope of activities in IAHR as Council member since 1988, with the Committee on Future Directions and Initiatives and as Vice President, before serving as president from 1996 to 1999.

In 1987 a Chinese translation of our book “Hydraulic Modelling” was published. I spent visiting research appointments in Shanghai, China 1988 and in Tokyo, Japan 1993, and in 2003 our student chapter YPN BW organized an extended excursion to China including a visit to the 3-Gorges project in its final phase.

The expansion of activities in the global network with its numerous Technical Committees and in the four Regional Divisions provided strongly increasing tasks for the IAHR secretariat, which according to General Secretary Henk Jan Overbeek needed a full time professional leadership. Christopher George was hired as the first Executive Director of IAHR in 1999. Simultaneously, the financial situation of IAHR became more difficult, and discussions with the host institute Delft Hydraulics led to the conclusion that another location of the Secretariat should be considered to allow IAHR to develop along its new professional avenue. An offer from CEDEX backed by the support of the Spanish government to host the IAHR secretariat was accepted, and the secretariat left Delft after 65 years and moved 2001 to Madrid with Cristobal Mateos as Secretary General, who in the meantime was succeeded by Ramon Gutierrez Serret. And in 2015, IAHR accepted a Chinese offer and established also an IAHR secretariat in Beijing, with Jing Peng serving as Secretary General. Thus, the organisation has now a firm global basis with two secretariats.

In 2005, the JHR published a special issue “IAHR 70 YEARS with the Water Scientific Community” with many contributions providing a good picture of the history of our organisation.

Recent developments

During the last decade IAHR has consistently continued to develop along its strategic goals. The close connection between research and practice in IAHR is reflected in the current issues of *HydroLink*, which show many examples of practical challenges, management concepts and research needs which have found attention. The decade with the presidents Nobuyuki Tamai, Roger Falconer and Peter Goodwin and the World Congresses in Australia, China, Netherlands, Malaysia and

Panama has demonstrated the continuous broadening of our engagement towards Hydroenvironment and Water Resources Management. And the new Council with president Joseph Lee will certainly continue along the strategic plan set up for 2019 – 2023.

On the global political agenda water has become an important item. Global warming and climate change has significant effects on the hydrologic cycle and causes rising sea levels, more frequent storms and more extreme cyclones, catastrophic flood events or dry periods with strong effects on agriculture and environment. And pollution or overexploitation of surface and groundwater resources, sedimentation and erosion problems, the “virtual water” issue - the challenges for hydroenvironmental engineering are tremendous.

Water resources management needs adequate solutions, and IAHR has the necessary state of the art prerequisites available. Hydrosystems models provide the tools for tackling problems of increasing complexity, and environmental systems models can provide the basis for interdisciplinary cooperations. Also the shift from physical to numerical models caused a corresponding shift from laboratory measurements to large scale field measurements. Modern observation and information systems with remote sensors are available and can be used both for the purpose of model validation or for monitoring the state of the water and environment system for prediction and control.

International communication has seen great developments in recent years. IAHR committees are promoting their work via internet and video conferences – an option that is booming presently during the Covid 19 pandemic and will certainly be more often used in future.

In the past 85 years the common goals of IAHR have always been promoted and guided by the voluntary engagement of our membership (the numerous outstanding members can not be listed here by name). Considering our history, we can be proud and optimistic that IAHR as an international network of engaged professionals will continue its way of tackling our professional challenges and thus contribute to a positive future of water and environment for the whole world. ■

References

- [1] History of Hydraulics, Hunter Rouse and Simon Ince, University of Iowa Institute of Hydraulic Research, USA, 1957
- [2] Hydraulics and Hydraulic Research, a Historical Review, Editor G.Garbrecht, Balkema A.A., Rotterdam, The Netherlands, 1987
- [3] Education of Hydraulic Engineers, IAHR/UNESCO Panel Report, JHR Volume 32, Nr.2, 1994
- [4] Hydraulic Modelling, Editor H.Kobus, DWVK/IAHR, 1980 (English translation of Wasserbauliches Versuchswesen, 1978)
- [5] IAHR 70 YEARS with the Water Scientific Community, Special issue, Supplement to JHR Volume 43/2005

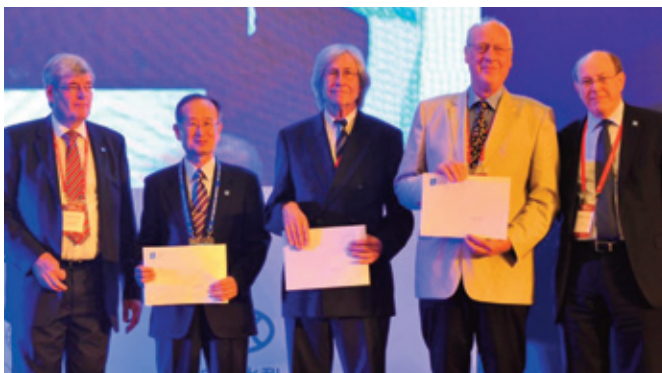

2013 Honorary Members Ceremony at the 36th IAHR World Congress in Chengdu, China. From left to right: Roger A. Falconer, Nobuyuki Tamai, Wolfgang Rodi, Willi H. Hager and Christopher George.



From left to right: Jing Peng, Joseph H. Lee, Arthur Mynett and Zhaoyin Wang.

RECENT IAHR ACHIEVEMENTS UNDER THE PRESIDENCIES OF ROGER FALCONER (2011-15) AND PETER GOODWIN (2015-19)

Each President of IAHR has tended to have his own influence on the direction of focus on IAHR and none more so than the two most recent past Presidents, Prof. Roger Falconer (2011-15) and Prof. Peter Goodwin (2015-19).

Professor Roger Falconer, President of IAHR 2011-15

When Roger Falconer was elected President at the Brisbane Conference in 2011 his election manifesto focused on making IAHR more relevant and appealing to practitioners and the wider hydro-environmental community. Key initiatives introduced to develop closer links with water practitioners and the wider hydraulics community included: broadening the Student Chapters and Young Professionals Networks to include post-doctoral researchers and graduate engineers and scientists working in local consulting companies and regulatory authorities etc.; launching two new IAHR journals; launching the new Technical Committee on Flood Risk Management; and developing closer relationships with other learned water societies, such as IWA, IAHS and IWRA.

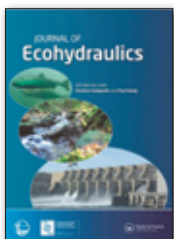

The first Student Chapter to be changed to the new format was at Cardiff University in 2012, where the chapter became a YPN and included a number of members from the local offices of international consulting companies, such as Arup, Atkins, Mott MacDonald, as well as from the Environment Agency, local Government etc. This model has proved to be highly successful and research students and associates now interact closely with recently graduated water engineers and scientists in local companies and government agencies.

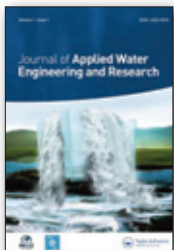

During Roger's presidency two new journals were established. Firstly, the late Prof. Michael Abbott (as well as others), had frequently expressed concerns that IAHR did not offer a journal that enabled case studies to be published. The Journal of Applied Water Engineering and Research was founded with the aim of publishing case studies, technical notes and papers with a practical application. Secondly, the Journal of Ecohydraulics was founded to address the growing engagement of IAHR members in ecology and with hydraulics being the vector of ecological parameters in river and coastal basin systems. The journal embodies the varied research undertaken in the field, covering aquatic life, ecology, biology, hydraulics, engineering, environmental science, climate change and other related fields, with an emphasis on the integration of these key disciplines.

The other key development during Roger's terms as IAHR President was the planning and launch of the joint IAHR Head Office in Beijing. In 2013 IAHR was faced with the challenge of finding a new home, following the need to address its growing membership in the Far East. The China Institute of Water and Hydropower Research (IWHR) kindly offered to host IAHR's joint Head Office and on 20 April 2015 IWHR's President, Dr. Kuang Shangfu, chaired the launch ceremony of the Beijing Office, with Mr. Gao Bo, Director General of the Ministry of



Launch ceremony of the Beijing Office, with Mr. Gao Bo, Director General of the Ministry of Water Resources, China, Roger Falconer, and Christopher George.

Water Resources, China, opening the ceremony. The event was attended by 120 IAHR senior representatives and Chinese dignitaries and the support and work of the Beijing Head Office has been a major milestone in the continuing growth and development of the Association.

Professor Peter Goodwin, President of IAHR 2015-19

Peter Goodwin was elected President of IAHR at the 2015 World Congress in the Hague. In addition to supporting past priorities, one of the strategic concerns discussed by the incoming Council was based on research by Dr. Chris George and others. What is the future of professional associations, and particularly IAHR in the era of 'Big Data', instant information and radically different modes of education and communication? This question initiated an extensive consultative process starting with town hall meetings with YPNs at IAHR events that generated important insights about how early career professionals can best benefit from IAHR. These YPN reports were enhanced by member surveys, further town hall meetings across the world, ideas from Technical Committees and Working Groups as well as several opportunities to contribute through the IAHR web portal. Unsurprisingly, the benefits included the opportunities to network with many of the top researchers from academia, research institutes, consultants and industry on a particular topic and with the opportunity for early career researchers to meet and receive mentoring from leaders in the field. The ability of IAHR to accelerate knowledge discovery through technical publications, international collaboration and exchange of experiences in managing water were among other factors highlighted.

The Council and a Governance Task Force worked for three years to formulate fundamental changes to the IAHR governance. Technical Committees, Regional Divisions, Working Groups and Publications are now an integral part of the Council enabling swifter implementation of ideas and initiatives. The Council now also includes a YPN member from each Regional Division to ensure the future of our profession has a direct voice in the Association.

At the end of this planning process, IAHR's first full-time Executive Director, Christopher George retired after 20 years of committed service. Tom Soo replaced Chris George and brings deep experience from other professional associations and the United Nations to IAHR. The exceptional staff in the expanded IAHR Secretariat has professionally organized numerous activities across the world such as the official launch ceremony of the Journal of Ecohydraulics in Beijing, the coastal management workshops in Spain and the Hydrosensoft conference series.

Through the leadership of Dr. Angelos Findikakis, IAHR has become a trusted adviser to the UN Sustainability Development Goals. In a closely aligned new initiative, Dr. Roberto Ranzi and colleagues from across the globe have created a focal point within IAHR to address the urgency of the most existential threat facing the world - climate change. This newly formed Technical Committee addresses the science of large-scale dynamic systems and how society and the environment will adapt to projected future conditions.

Peter Goodwin at the 37th IAHR World Congress Closing Ceremony in Kuala Lumpur.



On behalf of all the recent Presidents, it is important that we recognize the support of our host countries and the home organizations of Spain Water and IWHR that makes IAHR accessible across the world. Our dedicated Secretary-Generals Dr. Jing Peng and Dr. Ramon Gutierrez Serret maintain the high-profile of IAHR through their standing as technical experts in their respective countries. Thank you to Tom, Jing, Ramon and all the dedicated staff that makes IAHR a collegial and effective 'Association-of-Choice'. ■

SOME THOUGHTS BY THE IAHR SECRETARIES GENERAL

BY RAMON GUTIERREZ SERRET

As General Secretary of the International Association for Hydro-Environmental Engineering and Research, the IAHR, sharing the position with my Chinese colleague, Jing Peng, it is a great honor and satisfaction to have served the Association in this position since my appointment in 1995 and to today dedicate these words to such a pleasant occasion as the celebration of the 85th anniversary of the IAHR.

85 years of life of our Association are a long period, achieved with the effort of all those who have been part of the IAHR, its members, institutions and sponsors who have helped us, with material means and with financial support.

When back in 1935 the Directors of the main European hydraulic laboratories decided to establish the Association, with the spirit of spreading and sharing knowledge on water issues, they were already aware of the importance of WATER for the development of humanity and for disseminating and sharing knowledge on the areas of expertise championed by IAHR. My appreciation and thanks go to them. Subsequently, the most eminent scientists and engineers in the field of WATER -continental and marine- have joined with and continue to be a part of IAHR. Currently |our members -institutional and individual- come from 96 countries, a true international community of volunteers, whose purpose is to achieve better water future.

To the institutions and sponsors that in these 85 years have provided their support for the operation of the Association, starting with those |that hosted and host the IAHR, the then DELFT HYDRAULICS in the Netherlands (today DELTARES), then the CEDEX and SPAIN WATER in Spain and more recently the IWHR in China, the IAHR expresses its deepest gratitude to them, without whose support these 85 years |would not have been possible. This gratitude is extended to all those companies and individuals that have helped us financially, among others, SUEZ Spain and the Ministry of Water Resources of China.

However, in addition to all these grants and the annual contributions from our members, the IAHR needs to improve its financial situation and it has been working towards this goal for a long time and especially now. To have actions in the field of water - disseminating and sharing knowledge - financial resources are necessary. Our publications: magazines, monographs, books, White Papers and the daily operation of the Association require them.

In a changing and uncertain world, especially in this year 2020 with the problems derived from COVID-19, scientific knowledge and its practical application are essential, to which the IAHR is contributing in the field of WATER and will continue to do so, providing the knowledge of its members, capturing it through our publications, congresses, seminars, courses and other events. In this sense, I highlight our 39th World Congress in Granada (Spain) next year, in which I encourage readers to participate actively.

Finally, I would like to mention our Young Professionals who with their national and international networks are the future of IAHR and the members of the Council and the Executive Committee, especially the IAHR Presidents, current and past, who with their selfless work have made the life of the Association a reality over the last 85 years. A special mention also goes to the staff of our two Secretariats -Beijing and Madrid-, who with their dedication make the IAHR work.

And I end with congratulations to all those who have made this important IAHR birthday possible, with the invitation to those who are not yet members of IAHR and who carry out activities in the field of water to join us and finally with the desire for, at least, another 85 years of work of the Association at the service of society to achieve a better world in a global water context of environmental sustainability. ■

SOME THOUGHTS BY THE IAHR SECRETARIES GENERAL

BY JING PENG

The year 2020 marks the 85th anniversary of IAHR since its founding in 1935. 85 years, 38 Congresses, 4112 individual members, 129 institute members, 44 YPNs... All these numbers mark a glorious history of IAHR as it leads the international water and environmental research community, promote sustainable development both globally and locally, and connects scientists, engineers and practitioners. As a Chinese saying goes, unless you pile up little steps, you can never journey a thousand miles; unless you pile up tiny streams, you can never make a river or a sea. All the achievements of IAHR are the crystallization of the dedication and contribution of IAHR members as well as its partners and supporters around the globe from generation to generation. I am so proud of being a part of this brilliant community and to join this marvelous journey.

IAHR has brought me to a group of people with the most brilliant minds, the greatest personalities and endless enthusiasm to water science and engineering who share the same aspirations for future of the world. After I was appointed as the Secretary General of one of IAHR's two global secretariats, for which I feel extremely honored and pleased, I got more opportunities to participate in various working meetings and work together with IAHR colleagues including its leaderships and other members. Regardless of the frustrating long journeys and tight schedules, they always avail every minute and every opportunity to enhance the influence of the organization. The way they commit themselves to the work of IAHR and their innovative and

farsighted thinking for the organization have left an indelible impression on me. It is them and many more others with the same spirit and pursuit that have built the unique culture of IAHR that has been passing on from generation to generation.

The journey that we have been marching along has never been easy, and the way forward will also be full of challenges. The rapidly changing world is creating difficulties that we have never met before. We are celebrating our anniversary while COVID-19 is now still rampant throughout the world. However, we will never stop our steps and never lose our hopes because our mind is determined and our goal clear. This special year 2020 would later be remembered by all human beings because of our fearlessness and determination in face of the pandemic.

I am deeply convinced that IAHR will build on its good "old" days, adapt to the transforming environment, and progress with new ideas to stay relevant and "young". Before or against the wind, IAHR will blaze its trail into another era of innovations, prestige, and glory.

I feel so honored to be able to join this wonderful family of IAHR. As the saying goes, Only by connected, can beads become jewelry. I want to be a bead of special color that adds my unique splendor to the precious jewelry of IAHR. ■

85th IAHR Anniversary Summit

14-15 December 2020 (Mon-Tue). Beijing, China + Online



We are delighted to invite you to join IAHR's 85th anniversary celebrations in December 2020.

In the coming months we will be announcing a series of events to celebrate our achievements as the global leader in hydro-environmental research and engineering. These will range from a 2-day summit that combines offline conferences in Beijing and online sessions during 14-15 December 2020, live-streamed webinars, lectures, and a virtual get-together of prestigious IAHR members with the whole IAHR community.

Respected pioneers founded IAHR in 1935 to bring together global hydraulic research. Over the last 85 years, the association has evolved into a big family that consists of most of the water-related and environmental fields of research and practice, thanks to the strong support of our technical committees and working groups - our community.

The key themes of the summit are

- The role of Ecohydraulics and Nature Based Solutions in tackling global challenges
- Artificial Intelligence and Water: accelerating innovation and change
- Water in Africa: challenges and opportunities

To further push the boundaries of the endeavours of our community of academics and practitioners and celebrate the anniversary in IAHR's own way, we call for the leadership teams, especially the chairs, of all technical committees and working groups to work with the global secretariat to organise additional standalone online sessions, linked to their own thematic agendas (such as the IAHR Global Water Security 2nd Webinar – Linking Knowledge to Solutions to be held on 15 December). More than an academic feast, these sessions will also be gatherings for old and new friends to catch up and share stories.

Celebrating 85 years is not just about looking back. With the Strategic Plan 2020-2023 in place, we are now better positioned to, while reflecting on the many outstanding legacies of the past 85 years, work towards a better water future for all.

Contact us: Derek Cai, IAHR secretariat – derek.cai@iahr.org – +86-10-6878-1128.

Looking forward to meeting you this December both in Beijing and in the cloud.

WOMEN IN THE IAHR LEADERSHIP SHARE THEIR THOUGHTS

INTELLIGENCE THROUGH DIVERSITY – TOGETHER WE BUILD SCIENCE, TOGETHER WE ARE IAHR

BY SILKE WIEPRECHT

How would our life be in a society without men? How would our life be in a society without women? Boring, uninteresting, unbalanced, imperfect, not complete - simply, we would miss something. We are glad that we can live in a diverse community and can bring together and benefit from the skills, knowledge and strengths of all. Diversity is what makes us strong.

And it is precisely this approach that forms the basis of a fundamental principle within IAHR. The network of all members, whether greenhorn or old hand, whether from the northern or southern hemisphere, whether man or woman, is only as powerful through the existing diversity. However, there is certainly still room for improvement. Within IAHR we have a total of about 25% women members. However, this is distributed spatially quite unevenly: Latin America is the region with the highest proportion of women (27%), whereas in the Middle East and Africa women are the least well represented (15% and 11% respectively). It is also noticeable, nonetheless, that in the younger generation the distribution between men and women is already rather more balanced, at around 67% to 33%. More sobering, however, is the fact that very little has changed in recent years in terms of the increase in women members. We want to and must change this in order to further strengthen the potential of IAHR and its position.

That is why the Task Force on Gender Equity is working to further improve the balance between the different groups. Though, also within the Task Force we would like to see even more gender balance among the members. At the time being, we have a clear predominance of women in the Task Force. Men often do not think that gender equality is about them, and it is crucial that this changes. Often, gender equity discussions are dominated by women, while men make progress in research and other activities. Thus, it is important to encourage men to get involved and take responsibility. We explicitly invite the men of IAHR to participate and contribute to the Gender Equity Task Force.

Within IAHR we try to identify and raise the visibility of women who are active within the organisation. A balanced membership is one of our strategic priorities and it should be reflected accordingly at the leadership level, but also in our committees, divisions and boards. That this is not simply lip service, but that it is also being implemented, is demonstrated by the milestone modification of the new Constitution approved in Panama in 2019. It manifests itself in Article 17 which states that "*Members of Council (EC, TC, RD) should represent the gender and geographic distribution of the membership.*" Also, in Articles 7 and 8 of the By-laws can be found similar wording, which regulates the composition of the Technical Committees and the Regional Divisions accordingly.

Targets must be achievable and realistic. We are aware that the share of women in the engineering disciplines is approximately 35 to 40%, depending on the region. An equal split between the genders within

IAHR would therefore not only be unrealistic but would also not reflect our community. Therefore, our goal is to grow from 25 % to about 1/3 female members in IAHR within the next five years, and the divisions and committees should be appointed in the same ratio.

Nevertheless, we also know that it is not always easy to find enough women for all positions. In reality, the achievement of gender diversity often remains a struggle. If we want to create a gender-balanced board, workshop or committee, we can often only refer to a relatively small pool of women. This is why we endeavour to identify women leaders, develop the skills of our young women members, recognise their contributions and increase their visibility. To achieve this, role models are certainly an important element.

We are very excited to introduce four women from the new Council serving as role models. For the first time in the history of IAHR, the positions of the elected members of the Council are shared equally between men and women. The composition of the entire Council, including the President and Vice Presidents, the Secretaries General, the Division Chairs, the elected members and the co-opted members, is 30%. I think this is a remarkable success on which our further work can build.

Although there are so many amazing women in the water and environment sector, it is always interesting to note that it is still unusual to find women in leadership positions in the water sector. It is almost as if, as we become more technically and scientifically competent, we feel that it is unusual to find women among us. That needs to change. In the long term, we cannot and will not afford to waste and fallow potential of intelligent, motivated and creative women. We are looking forward to finding these great women together with you, to encouraging them to engage themselves and thus, together with our already committed male colleagues, to further advance the fate of IAHR. ■



Professor Dr. **Silke Wieprecht** is full professor at the Institute for Modeling Hydraulic and Environmental Systems of University of Stuttgart in Germany. Her emphasis in research is sediment transport. She is specialized in hydrologic and hydraulic analysis, flood protection with focus on risk analysis, aquatic ecology and especially in hydro- and morphodynamic processes in rivers (transport processes of particles and sediments) as well as research on biostabilisation of fine sediments. Her work includes field surveys, laboratory studies, analytical approaches for sediments, numerical modelling (in 1D, 2D and 3D) and hydraulic laboratory experiments. Professor Dr. Wieprecht is part of a well-established international network of notable researchers focused on sediment transport. She spent research periods as visiting scientist at several universities, i.a. UITM, Kuala Lumpur, Norwegian University of Science and Technology, NTNU Trondheim and Peking University PKU. She is head of several national and international expert committees. She has been member of IAHR since 2005 and serves as Vice-president since 2017.

LINKED IN DIVERSITY FOR WATER SECURITY

BY JING PENG

Water is an indispensable part of my life. As a woman researcher from the China Institute of Water Resources and Hydropower Research (IWHR), I am very honored and pleased to serve as one of the two Secretary Generals of IAHR as well as a Council Member of the organization. With 38 years of study and work in the field of hydraulics and water environment since my college days, I have been applying what I have learned about water to my work, while in turn learning more about water as I work with it. The more I work with water, the deeper I feel the great complexity and vital importance of water. It is such a unique resource that is not only complicated in its own natural sense, but it is also highly connected to many other natural resources and coupled with socio-economic development having an impact on many human activities. Integrating water into the UN SDGs reflects people's unanimous recognition of such complexity and the significance of water. It is because of this uniqueness, there is no universal solution to the water related problems or challenges of different countries or regions at different levels. Communication and cooperation are therefore necessary for us to share interdisciplinary knowledge and diversified experience of people all over the world.

IAHR, being a world-renowned professional community in the field of hydro-environmental research and engineering, has made tremendous contributions during its 85 years of history to inspiring, disseminating and catalyzing the state of the art knowledge and thinking on the most important water engineering and related environmental issues. However, the water challenges that we are faced with have never stopped changing as socio-economic conditions keep evolving and human activities and ecosystems are getting more deeply interwoven. Emerging challenges such as climate change, extreme water events from floods to droughts, water scarcity, water environment and ecological degradation, etc. are all threatening the global water security, which makes innovative solutions of water science and engineering more urgently needed and worldwide



Dr. **Jing PENG** is Vice President of the China Institute of Water Resources and Hydropower Research (IWHR) and Secretary General, International Association for Hydro-Environment Engineering and Research (IAHR).

She received her bachelor's degree of hydraulic machinery and master's degree of hydraulics and river dynamics both in Tsinghua University, China, and doctoral degree of river and basin environmentalology in Tokyo University, Japan.

Her major research fields include hydraulics, water environment and river ecosystem management. As project manager or term leader, Dr. Peng has been responsible for more than 40 research projects. She has also published more than 90 papers on journals.

cooperation and exchanges more keenly desired. As a member of the IAHR Council, I would like to share the research and practices of my team while learning from others through communication and exchanges on the platform of IAHR.

Water is the source of life. The good governance of water is the ultimate premise of a quality life for everybody on earth. To protect and use this valuable resource in a sustainable manner, we need to consider the interest of both current and future generations, and we need to look at this issue through different eyes, including those of women who might provide us with more diversified perspectives and inputs, and our children and grandchildren who will be living in the world that we leave them.

I hope that IAHR, as a world class professional networking platform, could make full use of its unique advantage of connections to researchers and engineers and even students all over the world, to bring together the immense power of human beings to jointly create a better water future for all. ■

AN OVERVIEW OF WATER AND GENDER ISSUES IN MOROCCO

BY DALILA LOUDYI

Morocco is a north African country with a long historical tradition of water management. Due to its landscape variety, ranging from coastal plains to Rif and Atlas mountain chains to desert dunes, disparities in water resources availability have always been a reality the country had to cope with. Systems of water sharing have been used as an expression of solidarity between small farmers; in addition, other traditional techniques have been developed in dry areas for water supply and conservation such as Noria, Khetara, Metfia, etc. In the early years following its independence, the country implemented a dam policy aimed at providing more equity in access to drinking water and agriculture development as the main economic activity of most Moroccans. The policy aimed at constructing 2 to 3 dams each year in order to irrigate one million hectares by the year 2000, to protect lands from floods and produce energy. Hence,

hydraulic engineering had soon become one of the most developed disciplines within national academic institutions working to respond to the policy needs for engineering technical and managerial resources. Subsequently, other related skills were also needed to adapt water resources management to demographic, socio-economic and, lately to climate change constraints. Therefore, many engineers and researchers were trained in the fields of groundwater, meteorology, coastal engineering, environment, water quality and other related disciplines, the main issue being water scarcity alleviation for food security, and social and economic adaptation.

However, in practice, these disciplines had always been male dominated. Adversely, in rural Moroccan practices, women and girls are the most involved in water management at domestic and farming

levels, particularly in water supply as they spend about four hours per day retrieving water in poor infrastructure areas. In this context, as a woman, water engineer and researcher, I am very much involved in the issues of water management in Morocco and in gender issues. I took part in many projects at national and international level in order to help the country facing the water crisis that hit the most vulnerable who are generally women, given the socio-cultural structure of domestic labor distribution and the weak empowerment of women in rural areas. I mainly work on climate change impact on water resources, flood and drought mitigation and adaptation, and urban water management.

Being conscious of the importance of networking as a researcher and professor of environmental water management for more than twenty years, I was interested in IAHR activities since the early stages of my career. I have published few articles in IAHR journals and magazine and took part to its conferences. Now, as a council member at the IAHR for MENA/ Indian subcontinent region, I am interested in promoting women access to decision making in the water sector in order to improve water access conditions, equity in water sharing and flood and drought resilience in one of the most water stressed areas of



Dalila Loudyi is a Professor at the department of Water and Environmental Engineering at the Faculty of Sciences and Techniques of Mohammedia, at Hassan II University of Casablanca. In 2005, she got her PhD in Hydroinformatics at Cardiff school of engineering. Professor Loudyi was selected by the Moroccan ministry of higher education as a National Contact Point in environment, since 2010, to promote the use of the Seventh European Framework Program (FP7) for research and development at a national level. She is also a member of the Climate change experts committee of LYDEC, a branch of SUEZ Environment in Morocco. In 2019, she was elected as IAHR council member for MENA/ Indian subcontinent region.

the world that is the Middle East and North Africa (MENA) region. IAHR is a good vector for water best practices exchange and networking between women in water engineering within IAHR and with the community of researchers and professionals for water innovative solutions. ■

WE ARE IAHR

BY AMPARO LÓPEZ JIMÉNEZ

I have been involved in IAHR since 1996, when I participated in my first Symposium on Hydraulic Machinery and Cavitation. Since then, I have been participating in IAHR meetings and organizing workshops and seminars. I am also part of the Spanish Chapter of IAHR and I participate in the IAHR Europe Regional Division Leadership Team. In addition, I am Associated Editor of Ribagua, our IAHR Journal in Spanish and Portuguese. Nowadays, I am also a member of the Europe Division of IAHR and member of the IAHR Council.

In my opinion, the future of hydraulic and environmental engineering involves the integrated management of water at any scale, as this provides not only economic long-term benefits, but also environmental and social benefits, as indicated by the Sustainable Development Goals of the UN. Hydraulic and environmental engineers must be fully committed to achieving these goals. IAHR must strongly lead this involvement with actions focused on information dissemination, networking and research in our field. My motivation is to promote these activities and to participate in them at any scale.



Professor **Amparo Lopez-Jimenez** gained the qualification of Industrial Engineer at the Universitat Politècnica de València and her PhD in the Department of Hydraulic and Environment Engineering (UPV, Spain). She is Full Professor of Hydraulic Engineering at the higher Technical School of Industrial Engineering, and Director of this Hydraulic and Environment Engineering Department.

She has been working on issues of Hydraulic and Environmental Engineering since 1994, preparing research and teaching ever since, in any aspect related to numerical modelling and sustainability issues, particularly related to hydraulic machinery.

Spain is a country where water management and all that it entails has great importance and tradition. Water is an increasingly valued and scarce resource. Universities and companies are working hard to find brilliant and innovative solutions that meet the needs of society in a sustainable and efficient way. The goal for all of us is to improve resilience to extreme and changing future scenarios, promoting the circular economy within the framework of an increasingly globalized world. In this context, the presence of women in the framework of hydraulic engineering has a lot to advance. In my country, approximately 25% of women students are getting an Engineer degree or Master, that is the proportion of students who finish their degree. But if we take a look at intermediate or senior management positions, that percentage drops to 12% or less. This means an egregious loss of women's talent for a number of reasons: women do not have references, they do not choose engineering studies, they do not enter in our Engineering Schools and in the end, society loses the possibility of benefiting from the many capacities of all those women who did not choose the world of engineering, and who could have contributed much to society.

It is time to bring women closer to the world of Hydraulic and Environmental problems, and to bring the full potential of Hydraulic and Environmental Engineering as a solution to young students who have to decide what vocation to develop. The world of Hydro-Environmental Engineering has a lot to offer to young men and women who discover their job interests for the future. IAHR, as an ambitious and committed association with sustainability, can be a mirror of these interests. Our Association must decisively have people involved in the proposal of innovation and technological solutions that allow solving the complex and varied problems that water and environmental management faces. Both men and women must be main actors in this future, which is common to all of us. ■

WATER FOR ALL

BY IOANA POPESCU

I have been an active member of the International Association for Hydro-Environmental Engineering and Research (IAHR) since 2001, and currently I am a member of the IAHR Council. I do know the association for a long time, and I have always appreciated its interdisciplinarity in water and environment, as well as the broad international composition of its members. This creates the opportunity to link to other experts and see different perspectives. I like in particular the fact that industry and academia come together to analyse problems of the aquatic environment.

Being a member of IAHR brings me closer to the worldwide experiences in water and creates opportunities for collaboration in research and educational activities with experts. In my daily work I have been involved in several large European collaborative research projects related to the field of information and communication technologies and water management (such as IceWater, Ienvis, EnviroGRIDS, Floodsite, SCENT). These projects involve various partners both from academia and industry, some of whom I met for the first time in IAHR.

Due to the nature of my work I am equally involved in educational and capacity development activities in Asia, Africa and Latin America, for modelling systems for water related domains. These activities support professionals in different countries. Through IAHR I hope we could



Ioana Popescu holds a PhD in Computational Hydraulics and has worked in the field of hydroinformatics for the past 31 years. I am currently Associate Professor of Hydroinformatics at IHE Delft - Institute for Water Education in Delft, The Netherlands. My research focuses on computational methods, flood modelling and flood related vulnerability, lakes and reservoir modelling, river systems modelling and optimisation.

develop an international recognition of these professionals, like an international licencing of professionals in water. In order to do that it is very important to maintain a strong link with young professionals.

Lately, my research is also focused on incorporating data generated by citizen observatories in flood models. I am also part of World Data Systems, and I believe in promoting the “open data sharing” concept. As part of IAHR, with new generations of professionals, formed in an era of big data availability, I hope to make a small contribution in moving towards data sharing, which will facilitate finding quicker solutions to water-related problems. ■

IAHR COMMUNITY – AN OPPORTUNITY TO BUILD LONG-LASTING PARTNERSHIPS

BY VERONICA MINAYA

I always had a strong connection with nature, and especially with water, which is what led me to follow my professional career in Ecohydrology. Nowadays, we face huge challenges in this field since we need to meet the current water demands but also to guarantee the sustainability of aquatic biodiversity. There are complex environmental and water management issues that need to be addressed using a sustainable and resilient approach.

I have been part of the IAHR community since 2015, when together with a group of colleagues we founded the IAHR-YPN Delft under the supervision of Prof Arthur Mynett. We organized technical sessions and social activities for the young professionals that attended the 36th IAHR World Congress in The Hague. Since then I have been really interested in research development, and women and youth empowerment. At the moment, I am an IAHR Council Member representing the Latin America Region, supporting the activities related to the Young Professional Network Development and the Gender Equity Task Force.

In Ecuador, water resources are threatened by the increase of demand for more food and energy, as well as by poor policies for water management. The government having recognized that the water resources are essential for the economic productivity of the country

and the welfare of its people, has started an effort to create new policies that aim at the sustainable management of these resources. Part of these policies include social equality and also the role of women in the integrated and sustainable use of the water resources. I see IAHR as a great platform to share information, exchange ideas and to build partnerships and initiatives. Senior researchers and water leaders inspire young professionals to have an active collaborative role within the IAHR community. As a Council Member I would like to support the interaction not only within the different YPNs, but also among them, and to support initiatives that promote and include the participation of women. ■



Veronica Minaya's background is in Civil Engineering, with degrees of Masters in Water Science and Environmental Engineering and PhD in Eco-hydrology obtained at UNESCO-IHE and TUDelft. Veronica was a post-doc researcher at the Vrije University in Brussels working at capacity development initiatives in the South, mainly Africa and South America. Currently, she is working as full-time lecturer in the Escuela Politecnica Nacional in Ecuador.

YOUNG PROFESSIONALS NETWORKS' PERSPECTIVES

BY SILKE WIEPRECHT - VICE-PRESIDENT OF IAHR



IAHR is an organisation that is concerned with all aspects of hydrology, hydraulics, hydraulic engineering and the important associated environmental issues, both in practical application and in science. We unite scientists and engineers from all water sectors from all over the world. We are a global network that brings together water specialists at different levels of experience. This is a great enrichment for everyone involved. We try to connect young scientists and young professionals with the experienced "old hands". In this way, young people can benefit from experiences already made and the existing profound knowledge. However, in the same way established members can find areas to learn more about the latest research developments and the most-recent technical approaches from the younger generation.

The water industry needs well-trained and motivated specialists, for whom excellent job prospects and interesting fields of activity in practice and science are waiting. Through its tight network, IAHR offers excellent opportunities to bring young and experienced people together. IAHR's Young Professionals Network (YPN) is an essential basis for this. We are proud to be an organization that has about 2000 members who are students, doctoral candidates or young professionals.

On the occasion of the 85th anniversary of IAHR, we are pleased that representatives of the young generation from four regions of the world are taking the opportunity to introduce themselves and their activities. They will also give an insight into how they view their career and the role of IAHR in a rapidly changing world facing some unique challenges. ■

IAHR POLAND YOUNG PROFESSIONALS NETWORK

BY THE IAHR POLAND YPN LEADERSHIP TEAM



Poland
Young
Professionals
Network

The new-born IAHR Poland Young Professionals Network started operating in January 2020. As a community, we are currently sparse, with members all around Poland, and a few international affiliates. We have different backgrounds and characters, but we have a common goal: sharing knowledge on water and environmental issues also with non-experts to foster good practices. We plan to increase our qualifications through organising meetings, webinars, conferences and gatherings. We want to identify problems important for young professionals in Poland and work on solutions and ways of addressing them and provide support for youth considering pursuing a scientific career. In the long term, we aim at creating an inclusive professional environment where the voice and opinions of the young generations in the field of water science are taken into account.

Being actively involved in international associations like IAHR can facilitate exposure, at both personal and scientific level and increases the possibilities for collaboration with recognized experts, therefore, opening new career paths. From an individual perspective, being an active YPN member requires a different set of skills than our research work, which enables personal and professional growth. Networks of young members are not only an advantage for the larger association in terms of memberships and initiatives, but they offer their affiliates a common ground for exchanging state-of-art knowledge and research outcomes, which brings benefits to the many research institutions present, eventually fostering better science. Opening up space for cooperation among different entities such as private and public organisations widens their perspective and offers many advantages, such as attracting funding for joint projects tailored to the local needs. Such networking enriches the young scientists and specialists in their

professional life by the establishment of personal connections with other young people with similar interests.

The IAHR Poland YPN would like to thank IAHR for the support in the first initiatives we are running, which, given the present global situation, are all planned online. We are focusing on improving soft skills crucial for our everyday work: from applying to projects to writing a good scientific paper. The adjustment to the ongoing situation forced us to make some changes in our activity plans, however, we believe that it is a good start for us and a very beneficial experience for the future. Most of us are young, and maybe a little bit of dreamers, with big plans to "change the world". In order to effectively tackle present water and environmental issues, single researchers are not enough. We see a big potential for IAHR to make a difference by supporting common projects and acting as a forum for related communication.

The challenge of our generation is to ensure the Right for information, knowledge and learning new skills related to the environment. We believe that science, in general, is underrepresented in the present educational system, and this has, with time, led to veiled negligence for the care of the environment supporting our existence. Water, air, soil, biota, are key elements of our lives, and still too little is really taught to young people, who are, for sure, eager to get their minds enriched with such knowledge. The greatest challenge for our generation is to make this real: only bottom-up awareness and education will allow building on the actual inequalities a more sustainable structure, and survive in connection with what the Earth can offer. ■

Please find us on Facebook: www.facebook.com/YPNpoland
Or contact us via email: iahrYPN.poland@gmail.com

IAHR PANAMA YOUNG PROFESSIONALS NETWORK

BY MARIA GABRIELA CASTRELLON, PRESIDENT

Latin America has about a third of the world's freshwater resources. Panama, with more than 500 rivers and an average annual precipitation of 2,924 mm, holds 0.1% of the world's surface water resources^[1]. Nevertheless, uneven water distribution both temporally and spatially, population growth, and climate change are creating distress and making it harder to achieve water security in the region. Hydrological models are useful tools to characterize and understand these eminent problems. However, finding good quality data with enough spatial and temporal resolution to feed regional scale models is a challenge. In my experience as a researcher working in Panama and California, I often face this conundrum. Now with remote sensing, crowdsourcing and Internet of Things (IoT) among other emergent technologies, hydro-environmental scientists finally have a chance to capitalize from big data analytics and machine learning techniques that are taking over other fields. As Dr. Dragan Savic points out, the key to achieve a digital transformation in the water sector is to train the next generation of water professionals as "hydroinformaticians", knowledgeable not only in hydrology and hydraulics, but also in programming and data science^[2].

As President and founder of IAHR Panama Young Professionals Network, I am focused on helping students and young professionals reach their full potential and become the water professionals of the future. Our chapter leadership team has proven to be resilient and innovative as it creates various online professional development activities for its membership amidst the current COVID-19 crisis.

The 38th IAHR World Congress, held in Panama City in September 2019, left a legacy in highlighting the importance of water research,

with the Panama Canal Authority (ACP) and the City of Knowledge at the core of this endeavor. As proof, amid the current pandemic, ACP's Board of Directors approved the creation of a new hydroscience research center in collaboration with the Technological University of Panama (UTP). According to Dr. Ricaurte Vasquez, CEO of ACP, one of the objectives of this research center is to develop AI technologies for the management of the Panama Canal Watershed (PCW) and seamlessly integrate them in the decision making process of the Canal's operations. This unique watershed is the ideal natural lab where young professionals like me could combine hydrological modeling, computational fluid dynamics (CFD), and hydroinformatics to develop regional scale hybrid models that run and calibrate in real-time, essentially functioning as digital twins of complex water systems such as the PCW. This initiative could not only serve as a research home for young Panamanian scholars like me, but also serve to attract international specialists affiliated with IAHR.

Given our many challenges regarding water resources management, water supply and sanitation, in Panama and Latin America we are in a position to turn our limitations into opportunities. IAHR could have a pivotal role fostering this region's for innovation by (1) accelerating the process of adoption and adaptation of current technologies; (2) reshaping the higher education programs for water professionals; and (3) promoting development of new technologies to solve water related issues sustainably. I believe IAHR would be the ideal partner to help Panama keep connecting the world through water and become the epicenter of hydroscience research and innovation in the 21st century. ■



IAHR NATIONAL UNIVERSITY OF SINGAPORE YOUNG PROFESSIONALS NETWORK

BY JAYASHREE CHADALAWADA - PRESIDENT

IAHR National University of Singapore (NUS) Student Chapter (SC) was first created in December 2008 by a group of 11 Hydraulic Engineering and Water Resources Management students. They were initially affiliated with Singapore Delft Water Alliance (SDWA) at NUS, established through an initiative of National Research Foundation (NRF) Singapore, involving Public Utilities Board (PUB), Singapore, Delft University of technology and Deltares, The Netherlands. The members greatly benefitted through participation in field surveys, excursions, seminars, IAHR congress etc.

The NUS student chapter progressed into a Young Professionals Network (YPN) Chapter over the last 10 years, currently working closely with the Ministry of Environment and Water Resources in Singapore to address issues of water and climate using advanced technologies. The key activities include:

1. Providing training on numerical modelling software (Delft3D, SOBEK, iMOD), computer programming (R, Python), spatial analysis software (QGIS) to industry professionals and students;
2. Working together with the NGO Earthwatch and the Hydroinformatics Institute (H2i), Singapore, to train citizen volunteers to monitor nutrient loads in multiple catchments impacted by different land-based activities across the island, over one year period, highlighting anthropogenic influence on algal blooms;
3. Participating in international research scholar exchange programmes;
4. Participating in international conferences and workshops on earth sciences.



The focus areas of this YPN Chapter in the water-stressed tropical urban environment of Singapore in 2020 and beyond include, among others, reviving the monitoring programme of the experimental Kent Ridge Catchment on NUS campus using state of the art sensors and remote data acquisition technology, thereby engaging more young bright minds in continuing the observation of rainfall, surface and sub-surface processes on a micro-scale. The Chapter also pursues projects related to long-term adaptation to climate change, through field research, well-crafted lab experiments, advanced numerical models and Artificial Intelligence.

Global Water Challenge - Prediction of future world's water supply and demand that requires,

1. **Deepening current Hydrological understanding** by dealing with the uniqueness of place and anomalies of existing laws using latest data acquisition technologies and hybrid modelling schemes.
2. **Environmental conservation programmes** for pollution control and coastal protection.
3. Accurate, high precision and scalable **Disaster early warning systems** for making critical life-saving information available to the needy in time.
4. **Weather-Resilient Water sources and Water Treatment technologies.**
5. **Dynamic Adaptation pathways** that can guide policy decisions resilient to deep uncertainties.

6. **Best management practices:**

- a. Groundwater Management.
- b. Harvesting Rainwater and Stormwater.
- c. Leak detection.
- d. Systematic Metering and Pricing schemes.
- e. Behavioral interventions to promote efficiency of end-users.



Main challenges for young professionals are,

1. **Keeping in pace with scientific advancements:**

Increase in computational power and availability of large datasets demands constant upskilling and thinking out of the box to customize recent algorithms (e.g. deep learning) to solve problems.

2. **Mastering the art of crafting effective research grant proposals relevant to the Place, Time and the Big Picture.**

The Singapore YPN Chapter is committed to participate in IAHR-facilitated platforms for widening personal and professional experiences, career development and online brainstorming sessions to promote inter-disciplinary research, international affiliations and regular knowledge exchange. ■

A PERSPECTIVE FROM AFRICA

BY CHARLENE GABA

My name is Ms. Charlene Gaba. I am a young scientist passionate about climate science and water resources. I am carrying out my current research studies at the University of Bonn as a fellow of the International Climate Protection (ICP) program of the German Alexander von Humboldt Foundation. I desire my work to be useful and communicated both to the scientific community but also to policy makers and sustainable development managers. For that purpose, in addition to scientific articles, the conception of a short video is envisioned. As a lecturer at the National Institute of Water, University of Abomey-Calavi, Benin in West Africa, I am very concerned to support the improvement of teaching methods and tools. A special focus is given to young women who need to be empowered in science. Additionally, plans are made to help them acquire more technical and programming skills.

We know how important water is for so many key development sectors such as drinkable water, extreme events (floods, droughts), agriculture, energy, ecology, farming, fishery, mobility among others. From my personal point of view, some of the big challenges of the future, if I look at it from the hydrological perspective, will be the short, mid and long terms predictions of precipitation. Although precipitation processes over Africa are generally well known, there are still high uncertainties with the results of models. Then, on top of that comes the low availability of ground climate data. This is the reason why I advocate for the expansion of low-cost environmental monitoring networks in order to overcome costs issues. More students could be trained in the use of

these new technologies in order to easily manage and maintain networks based on them.

I also have an interest in better sanitation conditions in the continent. In this perspective, I have contributed in collaboration with a team of the University of California, Davis to the elaboration of designs of a sanitary block that uses touchless sensors for water savings and better hygiene. The designs include also solar energy and clay material for more sustainable building. I have great expectations that this project could be implemented starting with a pilot phase in the future, but this is conditioned on granting of funding. We need to assess how local users will appropriate it.

Regarding the next steps in my career, I expect to find a research institution where I can actively contribute to the advancement of the knowledge on climate and water resources for the West African Region.

The International Association for Hydro-Environment Engineering and Research (IAHR), as a well-recognized international union would greatly help by bringing institutional support to some projects. Considering the large extent of the organization, IAHR could assist by contributing to the establishment of networks for further collaborations. ■



HYDRO-ENVIRONMENTAL EDUCATION IN AFRICA

BY MOEZ LOUATI, DAVID FERRAS & FELEKE AREGA

This article shares an opinion on how the ambitions and needs of African young Hydro-environmental professionals and students, particularly training and higher-level education, can be achieved under the umbrella of IAHR. With deep affinity for Africa and yet different backgrounds, the authors blend their standpoints concerning education, professional development and capacity building in hydro-environment engineering and research.

Common denominator throughout the diverse African countries is the pursuit of higher education, not only outside Africa but also within the continent. This has become one of the top priorities and ambitions for African students who are aware of the advantage in pursuing higher education, training and learning from other countries experience. Tunisia is a good case study to illustrate the trends in education, and the ambitions that African youths, students and young professionals are following, as well as the challenges faced in Africa. A recently published report^[2] provides information about the experience of sub-Saharan students in Tunisia. In fact, Tunisia has been attractive to foreign students since the 1970s, especially sub-Saharan students. At this moment, Tunisia has about 6250 foreign students (about 2% of the total number of students) in addition to a few thousand undertaking professional internships or training. Among these foreign students, about 75% (4560) are sub-Saharan students and the remaining 25% come mainly from the Maghreb. The main attractions for foreign students are that the quality of education, instruction in French or English, internationally recognized diplomas, shared religion and certain cultural practices, low living cost and ease in acquiring residency permit. However, Tunisia's proximity to the European continent and its lifestyle are elements that attract just as much, and possibly more so! In fact, for the vast majority of foreign students, studying there, Tunisia was their second or third choice. Europe remains their main destination (e.g. France, England, Belgium, Germany) followed by North America (Canada, United States) and then North Africa (e.g. Morocco). There are a number of reasons that drive the choice of Tunisia: the conditions for registration or obtaining visas in their first or second choice countries were not met, parents objected, the cost was too high, scholarships were not granted, etc. Certainly, local Tunisian students do not make exceptions in their choice of study and professional destination. Indeed,

IAHR visit to Kaseem Dam site- water intake, Ethiopia (2012). At the right IAHR President, Joseph Lee with Feleke Arega and representatives of the Local Organizing Committee of the 18th APD Congress.



upon completion of their degree in Tunisia, the majority of students (foreigners and locals) wish to continue their studies in another country (France and Canada being the most frequently cited), which seems to confirm that studies in Tunisia are a springboard towards a perceived "even better" elsewhere, the first step on the academic and professional path^[2].

In general, higher education studies and research in African countries are blooming. In Ethiopia, for instance, in 2018 more than 500 PhDs were awarded, while few years ago (in 2010) the number of awardees was only 21^[5]. In 2018, more than 3000 students were pursuing doctoral studies at local universities in Ethiopia. The majority (26.2%) studied natural sciences, followed by agricultural sciences (21.4%), social science (18%), engineering and technology (18%), medical and health sciences (6.9%), and humanities (8.7%). Nearly 80% of the PhD holders work in higher education while the rest are distributed in government offices (11.3%), private non-profit organizations (5.6%), and business enterprises (2.1%). The unemployment rate among PhD holders is 3%, not a negligible number. According to an interview published in IAHR Newsflash, 30 years ago only 3 universities provided civil engineering studies in Ethiopia, now there are more than 30 and have spread out through all the regions of Ethiopia. Hydro-environment research though still has to deal with many unknowns in Ethiopia and most

sub-Saharan countries, as many aspects of their problems and their potential solutions are site-specific.

Another common trend among students is their curriculum choice. The majority of African students choose to follow more engineering-oriented fields than literature and business. In fact, the majority of institutes in Tunisia (and in many other African countries) are in science and technology. The recent awareness of climate change and water scarcity^[1] mainly in Africa, but also worldwide, has increased the popularity of hydro-environmental profession. Such fields deal with complex systems and structures that emphasize the importance of multidisciplinary studies, with large data that require in-depth analysis and deep learning-hence artificial intelligence (AI) and data mining which are emerging fields of interest among science and engineering students. The quest for international higher education and training in hydro-environmental profession in Africa with a number of water challenges positions IAHR well for serving and empowering to the African hydro-environmentalists.

Some IAHR institute members contribute to this intercontinental mobility of students. An example of international mobility in higher education institutions is the International Hydraulic Engineering (IHE) Delft Institute for Water Education. According to a

IAHR Africa Ambassadors

comprehensive tracer study^[6] resulting from a survey of IHE Delft alumni on the relevance and impact of the education offered by the institute, the alumni from Africa are most positive about the impact of their professional activities on the development of their country/region, followed by alumni from Asia. Over 95% of the IHE Delft alumni return to their home country/region after graduation and over 87% remains active in the water sector for many years. As a result of this, there are a number of alumni developing their profession in important positions in their countries of origin. Most alumni are employed in the public sector, but there is a growing number of alumni working for private sector and international organizations. A comparison of the sectors showed a trend towards working on cross-sectoral water issues.

Having discussed the ambitions of African youths, the challenges they face and the trends in the education they are pursuing, and given the awareness of water scarcity in Africa and worldwide, it is of paramount importance to have a structure for capacity building and capacity development for Africa. In particular, there is a need for support by an international and diverse association that provides opportunities for water and environmental education to endow students and engineers with skills that allow them to face the challenges in Africa, and build bridges that would allow them to have easier access to their colleagues in the rest of the world.

The International Association for Hydro-Environment Engineering and Research is precisely what Africa needs! IAHR is probably the most international and diverse association in the field of water, hydraulics and environmental engineering. Being composed of four divisions, including an African division, IAHR is a worldwide independent organization of engineers and water specialists working in fields related to the hydro-environmental sciences and their practical application. The young professional networks (YPN) have successfully attracted students and junior engineers to engage in international events and networking. Moreover, IAHR has been a centre of attraction for students with their prestigious John F. Kennedy Student Paper Competition and the high-calibre Gerhard Jirka Summer School.

In fact, IAHR has already been supportive to Africa and its challenges. In the past eight years, IAHR has been reaching out to create a proactive engagement with Africa. In 2012, a delegation of representatives from the IAHR



Moez Louati obtained his B.Eng and MPhil degrees in Mechanical Engineering from the National School of Engineering of Sfax-Tunisia (ENIS), and received his PhD degree in civil engineering from the Hong Kong University of Science and Technology (HKUST).

Moez Louati left his home country Tunisia in 2011 to pursue his PhD study in Hong Kong. His travel was triggered only by the ambition to engage in higher education in a top international university with a system of education that encourages diversity, open minds, freedom of thinking, diverse campus facilities, and being well connected all over the world. If such a university and education system existed in Tunisia, Moez Louati may have never left.

His first interaction with IAHR was his participation in the JFK paper competition in the IAHR congress in Chengdu 2013 and it was the best professional and academic experience he ever had up to that moment. IAHR provided him with the experience to challenge himself and set his path to success in the academic stream, and with the opportunity to form relationships and friendships with his peers and leading members of his research community. Currently, Moez Louati is a Research Assistant Professor in HKUST. He is a member of IAHR, serves as a member of the editorial board of the *Journal of Hydraulic Research (JHR-IAHR)*, and is the chair of the working group on Transient Flows.



David Ferras obtained his PhD in the framework of a joint doctoral initiative between the Instituto Superior Técnico de Lisboa (IST) and the Ecole Polytechnique Fédérale de Lausanne (EPFL).

During his research he focused on experimental and numerical analyses of Fluid-Structure Interaction during hydraulic transients. Currently he holds a position of lecturer/researcher at the IHE-Delft in the department of Environmental Engineering and Water Technology in the area of Water Transport and Distribution. During his PhD David Ferras had the chance to participate in the 3rd IAHR Europe Congress in Porto (2014) and the 36th IAHR World Congress in The Hague (2015). With the motivation to advocate for the experiences and benefits that the association brings to young professionals, David Ferras enjoys participating in any IAHR initiative in which he can bring his contribution. He is currently vice-chair of the IAHR-EPD committee, editor of the IAHR NewsFlash World and member of the working group on Transient Flows.



Dr Feleke Arega obtained his B.Sc. in Civil Engineering from Addis Ababa University (Ethiopia), M.Sc. in Water Resources and Environmental Engineering from Hohai University (P.R. China) and Ph.D from Hong Kong University (Hong Kong) in Water Quality

modeling. He worked as postdoc in University of California, Irvine, Research Associate at US EPA Ecosystems Research Division. He is a registered professional engineer and worked for Tetra Tech and Arcadis USA. Now he works for South Carolina Dept of Health and Environment Control. He was a key person that helped support the 2012 IAHR visit to Ethiopia.

China Chapter and the Hong Kong Chapter made a five-day visit to Addis Ababa University, Ethiopia. During the visit, areas of collaboration were discussed. This was followed by a Special Session on “Challenges and issues of water resources management in Africa” that took place during the 35th IAHR Congress, Chengdu, China. In 2015, IAHR’s Hydrolink published its first special issue on Africa (issue 2015-4). IAHR can be a conduit for pro-active interaction between Africa’s practicing hydraulic professionals, students and policy makers and the wider international hydraulic practice, expert knowledge and research community. The IAHR African division aims to galvanize the practice, education and research in hydraulic engineering in a more sustainable, efficient and reliable way so as to overcome existing challenges, promote growth and development in Africa. There are a number of actions that IAHR can initiate, take part or collaborate to their successful development, namely:

- Develop a data base of knowledge expert, educational opportunities, tools and resources tailored to the needs of African issues.
- Form new Young Professionals Networks in African countries and establish links with existing African professional networks in water engineering.
- A dedicated Africa summer school could be established, focusing on lectures and training devoted to African water and environmental cases studies.
- Expand IAHR presence in Africa by means of a new IAHR office that would take care of the administrative duties of the African regional division.
- Enhance meaningful collaboration with key stakeholders such as the water affair ministers.

IAHR, as a non-profit organization, can offer support to Africa by connecting students, professionals, education institutes and policy decision makers with experts and world leaders in the field of hydro-environment. In particular, African students and ambitious youth would have a golden chance to showcase their work, their ability and be in touch with top leading professionals and professors of highly ranked universities. ■

References

- [1] Besbes, M., Chahed, J., & Hamdane, A. (2018). *National water security: case study of an arid country: Tunisia*. Springer.
- [2] Claessens E., Wague F., Bousbiih S., Belhaj A. (2018) *Attentes et satisfaction des étudiants subsahariens en Tunisie. Des portes qui s'ouvrent, des opportunités à saisir*. Report, TAT & ONMI (Tunisia).
- [3] IAHR NewsFlash (2020). *Focus on the African Region, IAHR Talks: interview with Prof. Yilma Seleshi*. May 2020 issue.
- [4] Lehrer, Jonah (2011). “The Itch of Curiosity.” Viewed on 13th August 2011.
- [5] Tamrat, Wondwosen (2018). The Meager Output of Ethiopian Ph.D.s. *The World View, a blog from the Center for International Higher Education*.
- [6] UNESCO-IHE report (2011). *Alumni Tracer Survey Executive Summary*.

ENCOURAGING CLOSER CONNECTIVITY BETWEEN IAHR AND AFRICA

BY JÖRG IMBERGER, ROBERT HUMPHRIES & MUSONDA JOSEPH MWANSA

The authors propose that the International Association for Hydro-Environment Engineering and Research (IAHR) establishes a technical water advisory group to assist African nations to create a continent in which water resources are considered holistically for the benefit of all its inhabitants and ecosystems.

Africa is a vast continent with 54 countries, a total population of over 1.3 billion, and more than 3,000 cultural groupings or tribes speaking over 2,100 distinct languages and practising a great number of religions. Further, the African continent holds around 30% of the world's known mineral reserves, including cobalt, uranium, diamonds and gold, as well as significant oil and gas reserves. Africa's richness in natural resources attracted great interest from developed economies, motivating the colonization of most of Africa by several European imperial powers between 1881 and 1914, which continued until the middle of the twentieth century.

Africa's history is full of examples of exploitation of the environment and its resources by external developed countries. This approach may have appeared to work reasonably well when the world was infinite and the healing power of nature could keep pace with the imposed rate of destruction. However, now that human reach and action have become global such behaviour has reached its use-by date, and is no longer compatible with the sustainability of humans on Earth. Those in the West must start listening to their African counterparts and learn to adopt a much broader outlook on the future of our planet and collaboration between nations. African peoples have achieved considerably greater harmony with their surrounding environment and the wild life in it than their western counterparts, but colonization has left its indelible mark. The long periods of foreign intervention at the government level have hindered constructive self-determination. Even though all African countries are now independent, there is still a reliance on outside developed economies to provide leadership and solutions for local problems, especially when it comes to providing a safe water supply and a responsible disposal of wastewater.

A common denominator of all humans is that their strongest motivating force is faith in a cause, be it in religion, in a certain way of life, in an economic model, in friendship, in a nation, or in a leader. If that faith is subject to external influences, as in African countries, then their people are left open to abuse.

The African Ministers' Council on Water:

Since the mid-20th Century Africa has undergone significant developments, including the gain of independence by all countries, with excellent progress and achievements in areas such as infrastructure and education. However, Africa still struggles with ensuring all its people have access to a high quality of life with clean, safe drinking water and responsible disposal of waste water. Africa has the highest per capita death rates due to water-related diseases and eighteen African countries lose around US\$5.5 billion every year from poor sanitation, with annual economic losses between 1% and 2.5% of GDP, according to a recent report by the World Bank's Water and Sanitation Program ^[1]

This situation has been officially recognized by all African countries and, in contrast to many other regions in the world, they can take credit for taking concrete steps by setting up the African Ministers' Council on Water (AMCOW) in 2002, with its vision of "an Africa where there is an equitable and sustainable use and management of water resources for poverty alleviation, socio-economic development, regional co-operation and the environment" and a mission to "provide political leadership, policy direction and advocacy in the provision, use and management of water resources for sustainable social and economic development and maintenance of African ecosystems" ^[2]

AMCOW has been very successful politically, but it would benefit from more international technical help. Water infrastructure in many

countries in Africa is rudimentary: this is responsible for water contamination that is significantly degrading the health and livelihoods of millions of people. There is an urgent need and opportunity for IAHR to contribute to the water authority officials in the various countries the relevant technical support that will help them gain confidence to improve their water supply and sanitation systems without fear of political interference. IAHR is the premier independent international water science and engineering association with a powerful network of experts who are well positioned to act as mentors for educational programmes to build the capacity needed for the sustainable operation of water and wastewater systems. The authors have been told that IAHR is keen to contribute to Africa becoming a continent that will act and perform in a more holistic fashion so that the water needs of humans and nature are met equally and excellently.

Proposed "African Water Advisory Committee":

A mentoring and collaborative programme for Africa would best be achieved by IAHR setting up an appropriately qualified group of water experts (here entitled "African Water Advisory Committee" or "AWAC") to assist African countries and local companies such as Global Empowers (<http://www.globalempowers.com/>) to improve their water supply and wastewater systems at all levels, from government administration to the technical details in a consumer's dwelling. Such an IAHR mentoring program would have three objectives:

- First, and most importantly, the African Water Advisory Committee would help AMCOW and the local water administration leaders increase confidence in what they are doing and so gain the respect of the stakeholders in their domains and be treated equally on the world stage.
- Second, AWAC would be an independent

entity providing a technical communication link between local African water supply staff and water academics, AMCOW, and world leading water researchers and administrators.

- Third, AWAC would set up a consultancy facilitation service, an "African Research Council on Water" ("ARCW"), with functions like those of the US National Research Council, so that if a particular African country, agency or company, needed a particular expert advice or service or if an African University wanted to hire a particular water expert, AWAC would have access to the necessary assistance.

So in brief, the African Ministers' Council on Water would make the political decisions on whether to proceed with certain initiatives using advice from the African Water Advisory Committee, which would ensure the necessary work is carried out using state-of-the-art technology appropriate for the task at hand, with the assistance of the African Research Council on Water.

The suggested structure would thus have two components:

- African Water Advisory Committee (AWAC), which may be likened to a Board of highly distinguished members to act in the manner of the US National Academy of Engineering, and
- African Research Council on Water (ARCW), the counterpart of the US National Research Council, staffed by competent water experts from different African countries.

In order to allow this structure to be implemented quickly, we suggest that AWAC initially be made up of 20 to 30 international researchers and practising engineers with expertise in all aspects of water supply, treatment and disposal for both urban and rural users. The first set of AWAC members would be drawn from the current IAHR membership, but on a ten-year time scale the intention would be for IAHR to step back and to help transition AWAC into an African equivalent of the International Water Academy, say the "African Water Academy", an independent internationally recognized academy, with the most distinguished African water engineers elected annually as members.

What we are suggesting would lead in ten years' time to an organizational structure similar to that which is working extremely well in the USA where the National Academy of Engineering is coupled with the National Research Council, both providing a purely

technical service to US government agencies, both State and Federal, and private interest groups. AWAC should provide the same service, with any registered African Water authority or company being able to request paid technical advice. AWAC would pass the request onto the sister organization ARCW, which would prepare the necessary service or report in conjunction with local contractors, and on completion provide a technical review of the product ensuring proper quality control. In the first instance AWAC would, as its title implies, focus only on issues associated with water but in the long term Africa may wish to broaden the focus to include other fields of science and engineering.

The First Ten Years of the African Water Advisory Committee:

a. Service Provider for the African Ministers' Council on Water: Again, the way the US National Academy of Engineering functions should be taken as an example. If a member of AMCOW should require a water-related service or report, the African Water Advisory Committee would solicit the African Research Council on Water to carry out the work and then the necessary quality control. AMCOW would then make sure that appropriate political actions were taken to ensure enactment of the recommendations.

b. Water Resources Inventory: When a country first signs up, AWAC/ARCW would carry out an inventory of the country's water resources, water supply systems and waste water management and prepare a water resources report highlighting deficiencies, strengths and future needs to satisfy the anticipated demographic, climatic and economic changes. The members of AWAC should be of sufficient international standing that these reports would not be questioned on technical grounds, once they had undergone the AWAC review process.

c. Research: AWAC would suggest particular research initiatives needed to clarify both internal and trans-boundary water issues in an African country, and if its suggestion is accepted, set up and help supervise the programs. An example of this type of service is the work done by the Centre for Water Research from the University of Western Australia on the quantification of the rate of transboundary water exchange and associated pollution in Lake Victoria between Kenya, Uganda and Tanzania. This helped to resolve a major potential political conflict between the three countries. Africa is a continent with several countries in both the north and the

south that are extremely water-poor, and Africa as a whole is very sensitive to global warming impacts. Much future hardship can be avoided if the most sensitive locations are first identified and then the necessary research is done to prepare for possible impacts from the changing world. An example of such a logic is the recent research project awarded to the Swiss Company Weathertec Services (<https://www.weathertec-services.com/>) by the Catholic Church to bring rain back to the Middle East.

d. Training of Water Industry Professionals:

It is well known in all aspects of life that prevention is very much cheaper than cure, and water infrastructure is no exception. ARCW would run a series of training courses, in response to requests or as they see fit, in order to educate water officials in different countries in the state-of-the-art best design and management practices in water supply, drainage and wastewater treatment and disposal. AWAC members would participate as guest lecturers. The courses could be structured so that attendees would receive an accreditation certificate. With the help of AWAC, such training could also involve participation in international programmes such as UNESCO and the World Meteorological Organization, in order to give Africa a voice.

e. Technology Transfer: Periodically IAHR/ARCW would organize exhibitions of new water-related technologies. AWAC members could provide keynote addresses. The following three examples illustrate the range of types of demonstration necessary to advance innovation and entrepreneurship in Africa:

- An Australian company is currently negotiating with a series of African countries to market a small water purification unit that can purify 50 kiloliters per day to potable standards from any source of water, at a very competitive price.
- Doust Plumbing Products (<https://doustproducts.com.au/>) has recently patented a new rainwater filter that is currently being marketed in South Africa.
- A small African start up (<http://vigoraqua.com/>) is setting up a marketing campaign for tablets that can be added to a glass of water to make the water safe to drink.

It would help all participants in water technology if AWAC/ARCW could provide, at the request of any African entity or company, a quality rating for any product in question. AWAC/ARCW could facilitate the introduction of such life-saving technologies by assigning safety and effectiveness ratings and so help



Jörg Imberger, the lead author of this proposal, knows water and knows Africa. Jörg Imberger in 1996 received the Stockholm Water Prize, also known as the Water Nobel Prize. He has been passionate in his love of Africa: from 1971, when he made a four-month journey with his wife, by public buses, along the East Coast of Africa from Cape Town to Addis Ababa in Ethiopia (Figure 1a), right up to recent times when he worked on a World Bank-funded project quantifying the horizontal mass transport in Lake Victoria.



Robert Humphries is a systems ecologist with more than 40 years' experience in environmental protection, waterway restoration and in the Australian water industry. He has visited and worked in countries in sub-Saharan Africa since the early 1990s, and with his wife reviewed South Africa's water legislation, including their proposed governance arrangements. Bob has a deep and abiding interest in the sustainable management of Africa's water resources.



Musonda Joseph Mwansa was born and raised in Mawaya village, in Kawambwa district, Zambia. He is the Founder of Global Empowers, a purpose-driven social enterprise that exists to uplift and free people to empower each other. Global Empowers, through the Water Does Matter project, is focused on reducing the poverty levels caused by contaminated drinking water by improving the health and living standards of rural communities in Zambia and across Sub-Saharan Africa through the provision of treated clean enriched water sources, and a water sanitation/hygiene education program in rural villages. Musonda is Professor Jörg Imberger's mentee and Member of the Australian Water Association. Musonda is also the author of his first book *The Source*.

African officials make better decisions. Such recognition would also foster peer-to-peer interactions and shift financing towards innovative, socially acceptable and sustainable local solutions

f. Adaptive Real-time Management: AWAC could supervise the introduction into Africa of new management strategies being implemented in technologically more advanced countries, for example adaptive management to replace static planning. This new management strategy involves setting up real-time, self-learning computer simulation technologies that mimic physical and ecological processes in the field. A country could have the quantity and quality of all its water supplies, as well as wastewater management processes, simulated in real time and in forecast mode including matching high resolution meteorological data. Simulations could then be tailored, country by country, using this



Figure 1a. In 1971 Jörg visited Haile Selassie's Palace and met a friend.

meteorological information to estimate water needs in terms of quantity and quality, factoring in the water requirements of particular cultures resident at the end of the water pipe. This technology has also recently been applied to wastewater disposal and assessing the impact of pollutant loadings on receiving waters. This new technology is particularly useful in preventing transboundary issues turning into political conflicts.

g. Set Up Teams of Water Ambassadors:

AWAC/ARCW could train school teachers in recipient countries to become water ambassadors. These chosen teachers could make primary and high school students aware of the need for better water supplies and the possibility of solutions. Children who would come into contact with such teachers would become champions for their local water supplies. An excellent example is the schools programme "Working for Water" in South Africa. The key issue was faecal pollution of rivers used for water supply, bathing, laundry, irrigation and livestock. Students collected water samples that were filtered on to a coliform culture medium. The small plastic Petri dishes were then taped into each student's armpit and incubated at 37 degrees Celsius without the need for an expensive laboratory! The students of course explained the process to their families, and after some time this led to improved sanitation and a reduction in water-

borne disease. This initiative should be coupled with initiative d. above.

h. Set Up International Support

Connections: The IAHR network could help connect top international talents across Europe, USA and Asia and the Pacific to those parts of Africa that most need support and ensure a transformative experience for those who share their skills to support local entrepreneurs or water programs. These international talented leaders could be identified easily in the international engineering Academies, so transitioning AWAC into an African Water Academy is the logical way forward. An Academy structure would then provide very clear additional advantages:

- Connection between Africa and the international water experts and companies would then become automatic, simply because members of international academies live globally.
- For African engineers and researchers being elected by their peers to become Fellows of the proposed AWAC would provide a clear and visible international recognition of their excellence.
- An Academy oversees the selection of a few very prestigious water prizes; the first could be an African Water Prize, with a stated bias towards those who have shown excellence in water sustainability. By focusing on the long term African contribution of living in harmony with nature, this would also provide a great trademark for the continent, in the new world in which we find ourselves.

Acknowledgement:

The authors would sincerely like to thank Professor Allan Barton for his editing. ■

References

- [1] World Bank, 2012: Economic Impacts of Poor Sanitation in Africa, <https://www.wsp.org/content/africa-economic-impacts-sanitation>
- [2] AMCOW website, <http://www.amcow-online.org/index.php?lang=en>

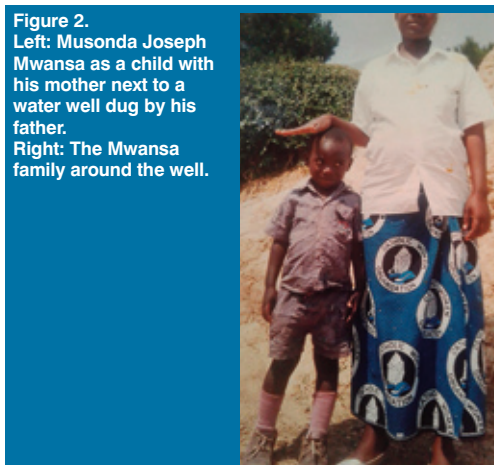

Figure 2. Left: Musonda Joseph Mwansa as a child with his mother next to a water well dug by his father. Right: The Mwansa family around the well.

INNOVATIVE SOLUTIONS AND NEW TOOLS FOR FISH-FRIENDLY HYDROPOWER

BY ATLE HARBY, LEA BERG & PETER RUTSCHMANN

Hydropower is an important renewable energy source, but often with adverse impacts on hydro-morphology and aquatic ecosystems. Under legislations, such as the Water Framework Directive, many hydropower plants in Europe will need to be refurbished or upgraded in the coming years to mitigate these impacts. The FIThydro project aims to find innovative methods, tools and solutions to safeguard fish populations and maintain electricity production in hydropower affected rivers.

Introduction

Hydropower is the largest source of renewable energy in Europe and worldwide. In 2018, hydropower provided 63 % of renewable generation globally, and 47 % of renewable generation in Europe [3]. With its adaptability, predictability and grid stabilisation possibilities, hydropower will continue to play a key role for the EU to meet energy needs and climate mitigation targets beyond 2020.

However, hydropower also can have a large impact on hydro-morphology, aquatic ecosystems, and fish fauna. This includes river fragmentation and impoundments, changes in habitat, flow, and sediment conditions, as well as blocking or delaying of fish migration and potential injury or mortality of fish from turbine or spillway passage.

To meet the goals and requirements of the EU Water Framework Directive (WFD) and other legislation, and to ensure an environmentally friendly, socially acceptable, and economically viable hydropower production, measures need to be taken to mitigate these impacts.

A large number of hydropower plants in Europe have been in operation for decades, and they are in need of refurbishment, redesign and upgrading. This requires technical improvements, adapted operational and management strategies as well as the implementation of mitigation measures to avoid any impact on aquatic ecosystems and individual fish as well as fish populations.

While the impacts of hydropower on fish, ecology and ecosystems are well known, there is still limited knowledge on how to quantify and reduce these impacts effectively. Furthermore, decisions on mitigation measures are often made on assumptions

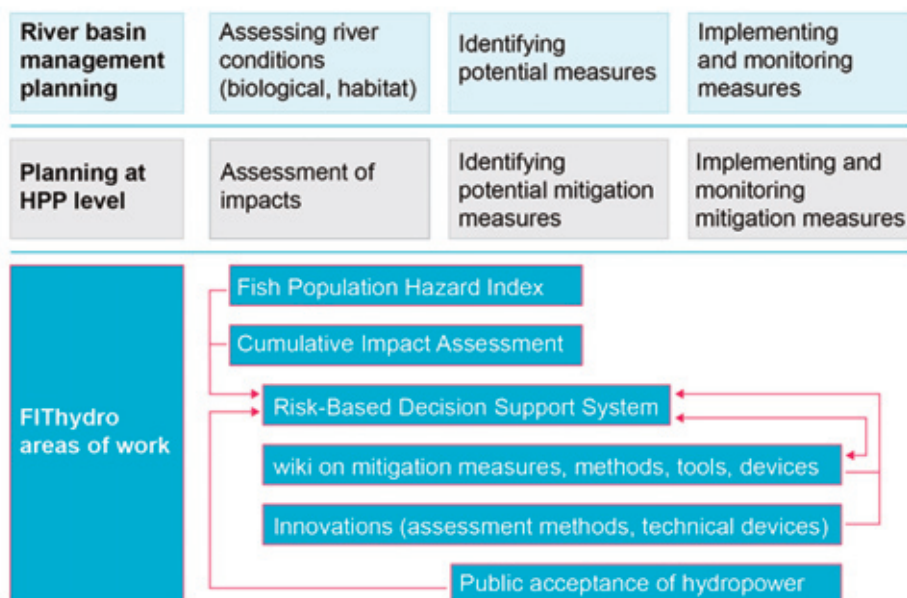

Figure 1. Key outputs from the FIThydro project in relation to planning of mitigation measures at hydropower plant level and to key relevant phases of river basin management planning. © FIThydro.

rather than on objective and scientifically-based knowledge, quantification, and models.

The FIThydro project began in 2016 to bridge this gap and improve the knowledge of and availability of innovative technologies and decision-making tools. The project consortium includes researchers, private companies, hydropower operators and engineering/environmental consultants.

Fish-friendly Innovative Technologies for Hydropower (FIThydro)

FIThydro is a 4-year Horizon2020 research and innovation action with 26 partners (13 research, 13 industry) from 10 European countries, involving several of the leading companies in the renewable and hydropower energy sector in Europe. The aim is to test and develop cost-effective environmental solutions,

strategies, devices, and measures to ensure self-sustained fish populations and increase the ecological compatibility of existing and new hydropower schemes.

Special emphasis was placed on the application and enhancement of technologies, methods, tools, and devices at 17 sites across Europe. These test cases were chosen to represent some of the main challenges facing hydropower development in four regions across Europe, namely Scandinavia, the Alpine region, France and Belgium for north-west Europe and the Iberian Peninsula. Scenario modelling in different geographic, climatic, and topographic test case regions will allow the quantification of effects and resulting costs for different mitigation options in Europe.



Atle Harby is a senior research scientist at SINTEF Energy Research in Norway. He has 25 years of experience in research and development with emphasis on ecohydraulics, environmental impacts of hydropower, water resources problems, climate

change impacts and energy storage technologies. He was the Director of the research centre CEDREN (Centre for Environmental Design of Renewable Energy), an interdisciplinary research centre for the technical and environmental development of hydropower, wind power, transmission lines and the implementation of environmental and energy policy. He is work package leader in FIThydro and leading its Case Study Management Board.



Lea Berg works at the Chair of Hydraulic and Water Resources Engineering of the Technical University of Munich. She is responsible for the communication, dissemination, and exploitation of the FIThydro project. Her background is in natural resources

management, sustainable development and education with a Master of Science in Sustainable Resources Management from the Technical University of Munich and a Bachelor of Arts from Maastricht University.

Peter Rutschmann is a full professor at Technical



University of Munich. He has 40 years of experience in hydraulic engineering and expertise in physical and numerical as well as hybrid modelling. He has managed some 50 hydropower projects, 35 sediment and flood management projects, and also a few eco-

hydraulic projects. He is one of the inventors of the innovative TUM hydroshaft powerplant and owns 8 patent families. Peter Rutschmann is a member of IAHR and the coordinator of the FIThydro project.

The key outputs from the project, illustrated in Figure 1, are two-fold: 1) A set of novel risk assessment and decision making tools to help practitioners evaluate, plan and find solutions for fish-friendly hydropower, and 2) a number of innovative and improved methods, tools and devices to address key challenges related to the assessment of self-sustained fish populations and fish-friendly hydropower production. A selection of the key outputs is highlighted in this article.

Novel risk assessment and decision-making tools

The scientific knowledge on the assessment of hydropower plants is largely limited by fragmented regional information on specific aspects, such as damage of single fish species or size classes, or a regionally

occurring species pool. To address this challenge, FIThydro developed the first European-wide guidance and assessment tool for fish hazards in hydropower environments, the Fish Population Hazard Index^[6]. This tool includes a population-biological sensitivity index and a conservation value index of European lampreys and fishes, as well as a mortality risk for fish and lampreys^[7]. Information on the characteristics of the hydropower infrastructure is needed to run this tool. The Fish Population Hazard Index supports the implementation of mitigation measures for sustaining and improving local fish populations and thereby for meeting the requirements and targets under European environmental policy, especially the WFD.

Furthermore, FIThydro developed a more comprehensive Decision Support System (DSS) to support the decision-making by assessing risks to fish populations in hydropower affected rivers. The DSS considers the specific hydropower plant characteristics, national environmental status assessments as well as environmental and conservation policies and mitigation requirements. It guides the user through questions and decision-trees to identify risks and hazards to fish populations and enable the screening of potential mitigation measures. The different DSS measures are described in the FIThydro wiki.

The FIThydro wiki (https://www.fithydro.wiki/index.php/Main_Page) is an open access online platform that provides an overview of and information on different mitigation measures for fish-friendly hydropower. The mitigation measures are classified according to hydropower and river characteristics, climate regions, fish species and physical conditions. For each measure, a set of methods, tools and devices for planning, implementation and maintenance are given. It provides users with the possibility to look up problems and solutions concerning hydropower and fish at a superficial, as well as a detailed level. The wiki enables deepening the knowledge of hydropower impacts and mitigation measures and can help users implement the appropriate mitigation measures for environmental problems caused by hydropower production.

Innovative methods, tools, and devices

During the project, several innovative methods, tools, and devices for fish-friendly hydropower have been developed or enhanced. This includes devices to improve the assessment of fish behaviour at hydropower plants, fish

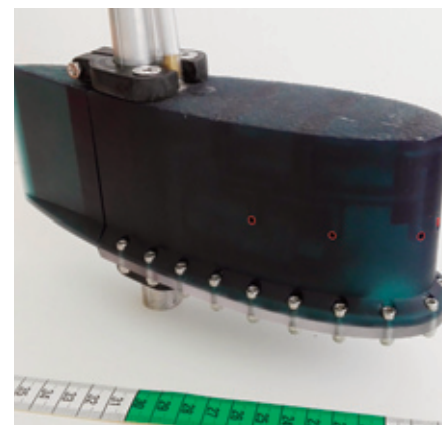

Figure 2. The “iRon” device, developed by the Centre for Biorobotics at the Tallinn University of Technology (TUT), that mimics the lateral line sensory system used by fish, is equipped with six differential pressure sensors that measure the pressure gradients simultaneously © Jeffrey Tuhtan, TUT.

guidance and protection systems, assessment methods for upstream and downstream migration facilities as well as tools for the assessment of impacts from hydropeaking.

The major obstruction to migrating fish is barriers such as dams and weirs. Fishways are the most common way to bypass the barrier and enable upstream migration of fish. However, the actual effectiveness of these structures is often unknown. Getting fish into fishways requires that fish can differentiate between the flow in the river and the flow entering from a fishway. Even though fish tracking in FIThydro indicates the need for additional stimuli, we usually assume that fish are mainly driven by sufficient “attraction flow”. Knowing exactly how the fish experience this flow and thus making it effective poses a difficulty. The “iRon” (Figure 2) is a device that mimics the lateral line sensory system used by fish in nature (artificial lateral line), and is the world’s first lab and field-ready instrument to capture flow “from a fish’s perspective”. It consists of a 0,22 m long streamlined body, which measures the pressure gradients simultaneously using six differential pressure sensors. In addition, the water depth is measured by the probe using an absolute pressure sensor. The “iRon” can be used not only to study flow velocity and turbulence, but also to sense the flow left-to-right and front-to-back, providing a sense of how fish detect obstacles and react to large-scale turbulences in real-world conditions.

The entrance to the fishway, the path to it and the consequent downstream swimming behaviour of fish during upstream migration was studied in several test cases during the project. The fish habitat simulation software

CASiMiR-Migration was used to model the fish swimming path during upstream migration by mimicking fish behaviour (Figure 3), as well as model migration corridors for different flow rates. The CASiMiR software enables investigation of the dynamic relationships between flow and biota in rivers, substrata, as well as in the connected bank and floodplain zones. Available habitats can be assessed for their migration suitability and be optimized.

Hydropeaking is becoming more important to balance the electricity grid with increasing shares of variable generation from wind and solar energy. FiThydro has developed a Hydropeaking Tool to assess the impacts on fish populations, considering different hydro-morphological impacts as well as the vulnerability of fish populations. The tool can help to document impacts and guide the user towards which factors to mitigate. The hydro-morphological impacts such as frequency, duration and magnitude of peaking, dewatered areas and ramp rates can be described from measurements or from hydraulic modelling.

There has been a lot of research and solutions for upstream migration of fish past dams and hydropower structures in the last few decades [5]. However, there is a lack of design standards and solutions for downstream migration. In the scope of FiThydro, fish guidance hydraulics and efficiencies are studied in laboratories and at test cases. Fish monitoring, velocity measurements and numerical modelling are conducted to investigate possible downstream fish migration measures and impacts.

Installations of fish guidance and protection structures in the headwater can reduce fish injury and mortality during downstream migration. Combining both, effective fish guidance and high hydraulic performance to avoid power losses is often a challenge. The newly developed Curved-Bar Racks (CBR) are mechanical behavioural fish protection and guidance structures that consist of vertical curved bars with an adjacent open channel bypass (Figure 4). CBRs present a technical solution for both effectively guiding fish and maintaining hydropower production and operation. The results from extensive laboratory tests show that the CBRs provide high fish protection and guidance efficiency for most of the tested fish species endemic in Central Europe. They also show significantly improved hydraulic performance, i.e. reduced head losses and uniform turbine admission flow [1], [2]. CBRs have great potential for

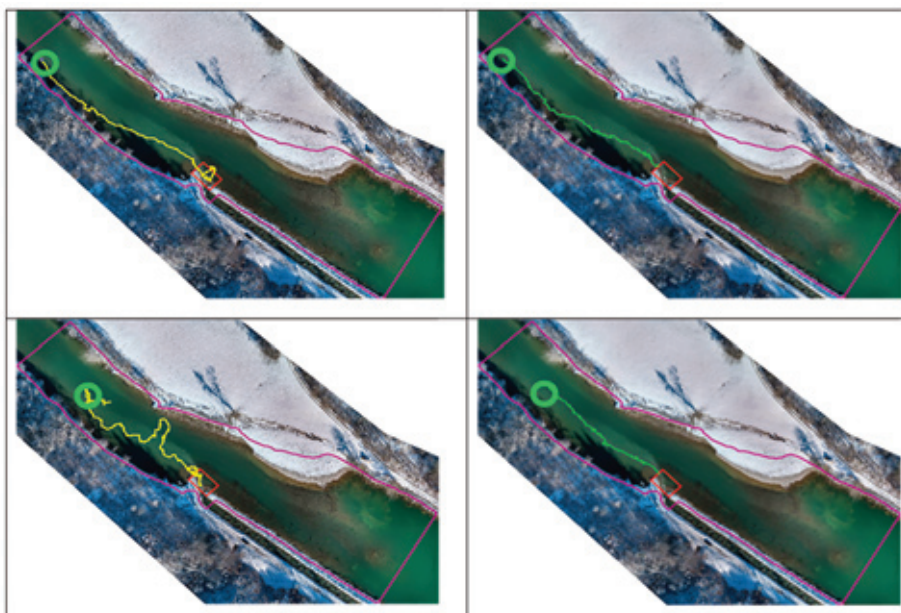

Figure 3. Comparison of the observed fish tracks (left, yellow) and the modelled fish agent tracks (right, green) created with the CASiMiR-Migration software, developed by SJE Ecohydraulic Engineering, to model migration pathways at the test case Altusried at the river Iller in Germany © SJE.

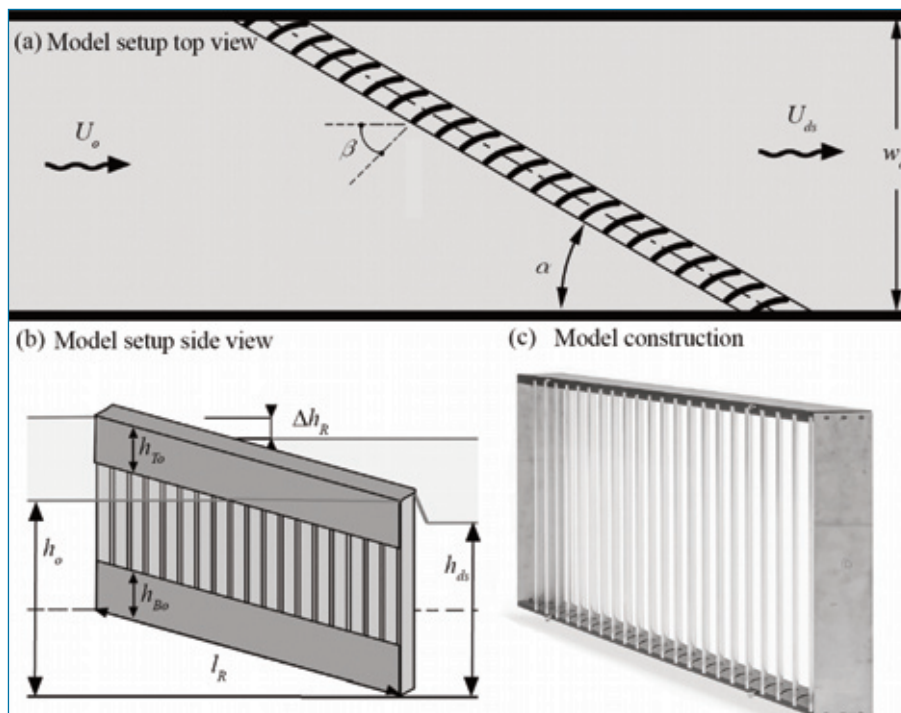

Figure 4. Illustration of the Curved Bar Rack fish protection and guidance system, developed at the VAW lab of the ETH Zurich, in top (a) and side (b) view, as well as (c) the model construction. © ETH Zurich, VAW.

prototype hydropower plant application. They are suitable for medium-to-large hydropower plants with high design discharges ($Q > 100 \text{ m}^3/\text{s}$) and high approach flow velocities and could be an alternative to fine-screened horizontal bar racks for small hydropower plants.

In many small and medium-sized run-of-river hydropower plants, the only way for

downstream migration of fish is through turbine passage. Fish may experience adverse impacts as they pass through the turbines, ranging from potential injury to mortality [6]. To quantify the hydraulic conditions, which can lead to pressure induced mortality, and gain accurate measurements, the Barotrauma Detection System (BDS) was developed and applied in several test cases. The BDS is an advanced waterproof

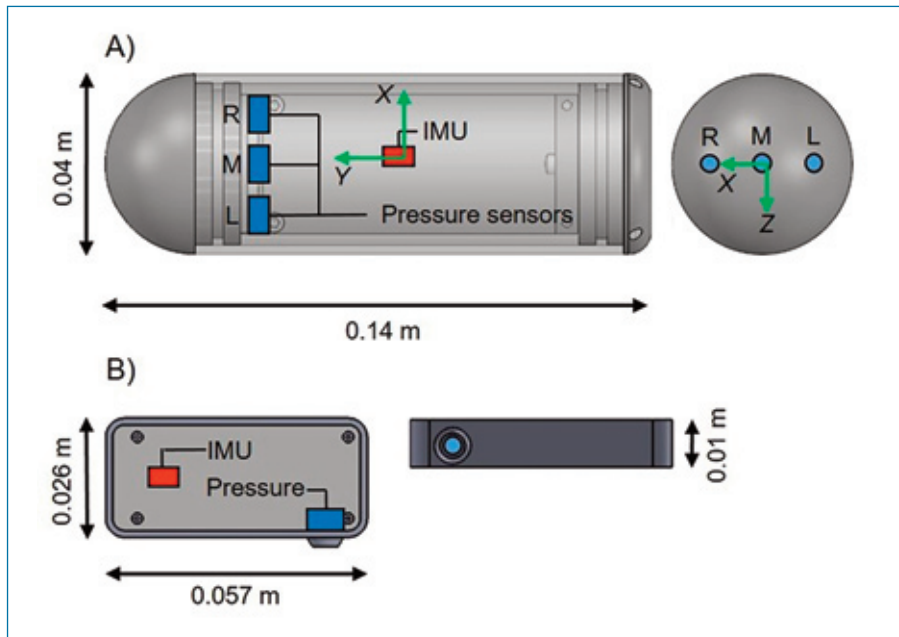

Figure 5. Illustration of the Barotrauma Detection System (BDS) and sensor tags, developed by the Centre of Biorobotics at the Tallinn University of Technology. © Jeffrey Tuhtan, TUT.



Figure 6. Calibration of the BDS sensors in the laboratory © Jeffrey Tuhtan, TUT.

autonomous sensing array (Figures 5 and 6) that can be inserted into the hydropower plant to collect information on the pressure and inertial changes that fish experience. Its three pressure sensors are auto-calibrating and provide fault-tolerant data collection and data quality control for each measurement while also recording its absolute orientation. They have been deployed at the test sites of Ham (Belgium), Bannwil (Switzerland), and Guma and Vadocondes (Spain). The BDS will help hydropower owners to assess the impacts on fish passing through turbines, and it can be used to identify where turbine passage is acceptable.

Conclusions

Hydropower plays an important role in producing renewable energy as well as enabling better integration of variable renewable generation from wind and solar power. At the same time, there is a strong need to improve the ecological status of rivers and catchments, and it is vital that negative impacts of hydropower on fish and the aquatic ecosystem are mitigated.

FIThydro has drawn together scientists, consultants, and hydropower operators from across Europe to test, develop and demonstrate innovative methods, tools, and devices that support managers, engineers, ecologists,

and hydropower operators on the way towards sustainable hydropower generation.

This article introduced selected key outputs of the FIThydro project that support the assessment, planning, commissioning, and operation of ecological compatible and fish-friendly hydropower schemes. The tools, devices and technologies presented here are available for use and will also be further implemented, tested, and potentially adapted by project partners.

In addition to these main outcomes, the project deliverables include extensive information, data, analysis, and results of relevance to researchers in the field of ecohydraulics. The deliverables include an extensive list of existing solutions, models, tools, and devices to attain self-sustained fish populations and their application range, a metadata overview on fish response to hydropower and guidelines for mortality modelling. These publications and results are freely accessible and can be used as a basis for further research and development towards improved fish protection and hydropower impact mitigation.

Most of the results, deliverables, tools and scientific articles of FIThydro are accessible via the project website <https://www.fithydro.eu>

Acknowledgements

The work and the ideas described in this article are the product of contributions of many people from the 26 partners in FIThydro. This project received funding from the European Union's Horizon 2020 research and innovation programme under grant agreement no. 727830. ■

References

- [1] Beck, C., et al. (2019). Hydraulic performance of fish guidance structures with curved bars: Part 1: Head loss assessment. *Journal of Hydraulic Research*, <https://doi.org/10.1080/00221686.2019.1671515>.
- [2] Beck, C., et al. (2019) Hydraulic performance of fish guidance structures with curved bars: Part 2: Flow fields. *Journal of Hydraulic Research*, <https://doi.org/10.1080/00221686.2019.1671516>.
- [3] IRENA (2020) <https://www.irena.org/Statistics/View-Data-by-Topic/Capacity-and-Generation/Technologies>
- [4] Kampa et al. (2020). FIThydro Policy Brief. <https://www.fithydro.eu/reports-other-publications/>
- [5] Silva, AT, Lucas, MC, Castro Santos, T, et al. (2018) The future of fish passage science, engineering, and practice. *Fish Fish*. 19:340–362. <https://doi.org/10.1111/faf.12258>
- [6] Stoltz, U. and Geiger, F. (2019) D1.3 Guidelines for mortality modelling. Available at: <https://www.fithydro.eu/deliverables-tech/>
- [7] van Treeck, R., Van Wichelen, J., Wolter, C. (2020). Fish species sensitivity classification for environmental impact assessment conservation and restoration planning. In: *Science of the Total Environment* 708, <https://doi.org/10.1016/j.scitotenv.2019.135173>
- [8] Wolter, C. et al. (2019). D1.3 Fish Population Hazard Index. <https://www.fithydro.eu/deliverables-tech/>

MINIMIZING THE REQUIRED SURGE VESSEL VOLUME BY AN IMPROVED THERMODYNAMIC MODEL

BY SAM VAN DER ZWAN & IVO POTHOF

Surge vessels are the main protection mechanisms in most long-distance water transport system. They are designed with the help of water hammer software, which mostly uses the ideal gas law. This leads to a conservative design. This article will show that using a more detailed model of the behavior of the air inside the surge vessel, can lead to a less conservative design and thus reduce the costs of the system. It will summarize the present state of the research into a new model for the thermodynamics of surge vessels.

Water transmission schemes are used around the world to transport water from the production sites towards the distribution networks. These transmission schemes start with a pumping station, where tanks, pumps, and surge vessels are installed; see Figure 1 for an example of surge vessels. The next part is a long transmission pipeline, which runs from the pumping station to a valve station after which the water is discharged into tanks or reservoirs.

To ensure the safety of the pipelines, surge vessels are installed just downstream of the pumps, see figure 2 for an example schematic of a pumping station. After a full pump trip due to, for example, a power failure, these surge vessels start to supply water to the pipeline. This makes the transition from full flow to zero flow smoother, thus reducing the minimum pressure reached after the full pump

trip. The surge vessels are designed in such a way that the minimum pressure is acceptable and that the surge vessel does not drain.

The basic working principle of the surge vessel is the expansion and compression of the air inside the vessel. This dampens the pressure waves and therefore reduces the extreme pressures within the system. The bigger the air cushion the better the downstream system is protected from pressure surges. In this lies the need for optimizing the size of the surge vessel, since a bigger surge vessel will be more costly. Water hammer simulation software plays an important role in the optimization of the surge vessels. In this type of software, the physics of the functioning of the surge vessel is been taken into account in a simplified way. In reality, the behavior of the air inside the vessel is more complex. For example, the air will cool



Figure 1. Surge vessels in the United Arab Emirates from [1].

down when expanding. This can start a flow of heat from the outside air into the surge vessel, the amount of which depends on the temperature difference, the wall thickness of the material of the surge vessel, and on the dimensions of the surge vessel. However, it is difficult to account for this heat transfer, and therefore in most water hammer software programs, two extreme cases are considered: no heat transfer and constant air temperature equal to the outside temperature (i.e. instantaneous and unrestricted heat transfer). These two extremes lead to a simple equation known as the ideal gas law. The behavior of the air is described by the so-called Laplace coefficient or adiabatic index.

When using the ideal gas law, these two extreme cases need to be considered. The case that there is no heat transfer is also known as an adiabatic process, for which the Laplace coefficient of air is 1.4. This leads, in general, to the lowest pressure in the system. The other case is also known as isothermal expansion, with a Laplace coefficient of 1.0. This leads to the lowest water level in the surge vessel. To come to a safe and reliable design both need to be considered. It is not possible to exclude one or the other since it is not known beforehand which of the two will be the dominant process. As it has been shown [1], this leads to a conservative design of the

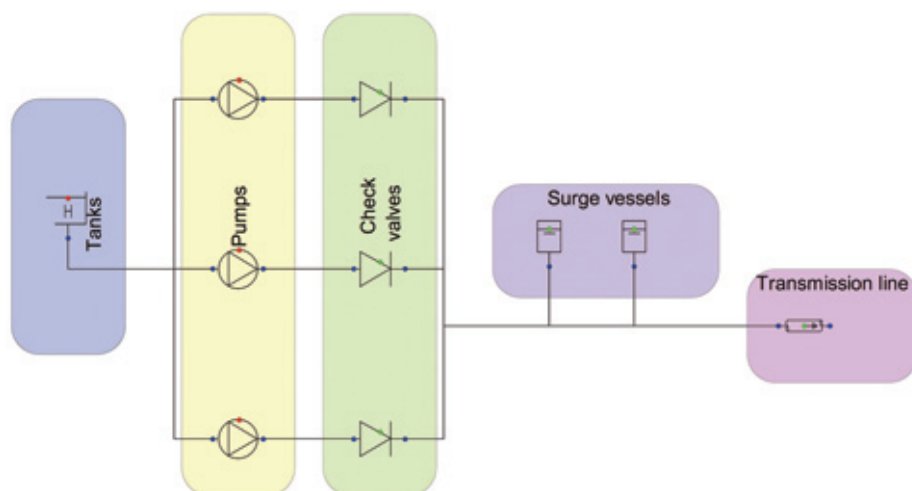

Figure 2. Schematic overview of a pumping station and a transmission line.

surge vessel. A 20% reduction in surge vessel volume can be obtained when the behavior of the air or Laplace coefficient is known beforehand, as can be seen in Figure 3^[1] which shows the required surge vessel volume for different values of the Laplace coefficient ranging from isothermal expansion (1.0) to adiabatic expansion (1.4). This figure is created by finding for the different surge vessel volume the acceptable C-value (product of initial air volume and initial air pressure). This is done for the minimum water level in the surge vessel and for the minimum acceptable pressure in the system. This results in two lines for every Laplace coefficient, the area between the lines (white part in figure 3) represents acceptable combinations of surge vessel volume and C-value. From figure 3 it can be seen that a surge vessel volume of about 575 m³ (blue dot in figure 3) is required. If the Laplace coefficient would be 1 the total required volume would reduce to 475m³. The actual, more realistic Laplace coefficient can be predicted if the heat transfer is considered in the modelling of the surge vessel^{[2], [3]}.

The heat transfer from the outside air to the inside air and the heat transfer due to the condensation of the water vapor needs to be modelled. The difficulty is the estimation of the heat transfer coefficient, which dictates how much heat is transported from the outside air

into the air inside the surge vessel. Two processes play a role in this. One of them is the heat transfer through the wall, which depends on the material (steel in most cases) and the wall thickness, both of which are known. The second process is the heat transfer inside the surge vessel, where the air is at a standstill and the heat conducted through the wall increases the temperature of the air close to the wall. Then, due to collisions of the air molecules the heat is slowly transported towards the center of the surge vessel, i.e. through diffuse heat transport. Next, free convection is induced, a motion of the air molecules driven by the density difference, resulting from the temperature difference of the air inside the surge vessel. This process depends upon the geometry (size, orientation) of the surge vessel, the temperature difference between the air inside the surge vessel and the ambient temperature. It can be modelled by calculating an overall heat transfer coefficient with the help of the Nusselt number, the ratio between the overall heat transfer and the heat transfer by conduction. Several relations for different geometries can be found in literature^[4] but, there is none for heat transfer inside a cylinder.

A comparison between 3D CFD simulations and simulations with extended rational heat transfer model (eRHT) model^[2], which estimates the rate of heat transfer using the

Figure 3. Graph from^[1] showing the required surge vessel volumes for the Laplace coefficient, the colored dots show the required surge vessel volume for different Laplace coefficient (1.0 is red, 1.2 is green, 1.4 is black, the design is blue (the combination of 1.0 and 1.4)). The x-axis shows the surge vessel volume, the Y-axis shows the C value, which is the product of initial air volume and initial air pressure.

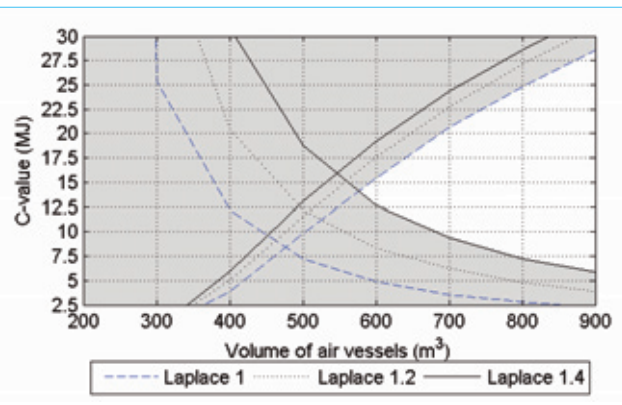
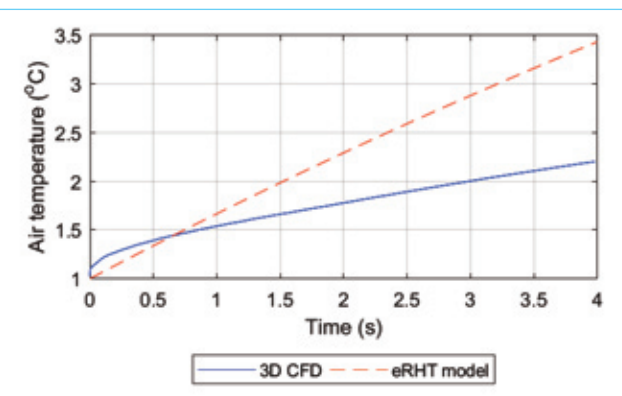

Figure 4. Comparison between the improved model for the expansion of the air including heat transfer compared to 3D CFD simulations from^[5].



Sam van der Zwan has been working in the field of fluid dynamics in the pipelines system for the past 12 years at Deltares. He has been working on the design for several large water transmission systems in the United Arab Emirates. Next to this, he is one of the main developers of Wanda, the water hammer package developed by Deltares.



Ivo Pothof (Ph.D., MSc, 1972) has a background as an industrial hydrodynamics specialist at Deltares, performing applied R&D projects for the water and energy industries. Joining Delft Hydraulics (currently Deltares) in 1997, he became a specialist in fluid transients, optimal control of pipeline systems and air-water pipe flows. [His book chapter on transients in water supply systems](#) has been downloaded over 25,000 times worldwide. His Ph.D. thesis on air-water flows in downward sloping pipes is directly applicable to (waste)water, cooling water and hydropower outlet works. Currently, Pothof focuses on Renewable Energy from Water and Underground. He has published in various peer-reviewed journals, numerous conference proceedings, and national popular-scientific journals.

Nusselt relation for an infinite flat plate. shows a significant overestimation of the heat transfer compared to the 3D CFD simulations^[5] (see Figure 4). This is the subject of ongoing research, whose main goal is to develop a relationship that can predict the heat transfer inside the surge vessel. 3D CFD simulations are used for this purpose. Next, the surge vessel model needs to be validated against measurements. For this purpose, laboratory and field measurements are planned.

The new and improved model for the air expansion in a surge vessel is still under development. When finished, it is expected to help reduce significantly the required volume of surge vessels, thus reducing their construction costs. The main focus of the ongoing research is the heat transfer modelling and the validation of the model with measurement data. ■

References

- [1] Zwan, S. van der, Rudolph, D., Balkema, S.H., Pothof, I.W.M., Leruth, P.H., Optimization of surge protection for a large transmission scheme in Abu Dhabi, 2012, 11th Pressure surge conference.
- [2] Zwan, S. van der, Tousaint, M., Alidai, A., Pothof I.W.M., Leruth P.H. Thermodynamics of surge vessels 2015, 12th Pressure surge conference
- [3] Haakh, F. Transient thermodynamic processes in air chambers with a gas cushion for surge protection, 2018, 13th Pressure surge conference
- [4] Janssen, L.P.B.M., Warmoeskerken, M.M.C.G., Transport phenomena data companion, 2001, third edition, Delft University Press
- [5] Zwan, S. van der, Kooreman, S.L. Comparison of the extended rational heat transfer model with 3D simulations, 2018, 13th Pressure surge conference

CEDEX STUDIES TO IMPROVE THE SAFETY OF THE EBRO DAM

AN EXAMPLE OF SUSTAINABLE MAINTENANCE OF THE HISTORICAL HERITAGE OF SPANISH DAMS

BY LUIS BALAIRÓN & MARÍA ISABEL BERGA

The Centre for Hydrographic Studies of CEDEX has actively collaborated in recent years with the Ebro River Basin Authority to adequately maintain the Ebro Dam level of service by developing several technical studies and improvements in its structures. The hydrology data has been updated and two hydraulic physical model studies have been carried out to analyse its two main hydraulic structures (spillway and stilling basin).



Figure 1. Stilling basin of the Ebro Dam. Drawing by Manuel Lorenzo Pardo. [1]

The Ebro Dam

Spain has a long tradition of dam construction, with more than 1,200, some of which built in Roman times, such as Cornalbo and Proserpina, and are still in service. The age of some of these dams may require the review of the hydrological studies under which they were designed, since in many cases the hydrological information available for their design was very scarce.

On the other hand, it may also be necessary to modify their discharge facilities in order to adapt them to the current safety standards. Given the historical interest of these infrastructures, their adaptation must be carried out carefully, verifying with hydraulic studies on physical models the suitability of the proposed solutions.

The Ebro Dam built in 1952 is almost 70 years old. Much more hydrological information is available now than when the dam was designed. In addition, some hydraulic inefficiencies have been identified in its operation over the years, so its design requires updating.

The Ebro River is the largest in Spain with a length of 920 km. Its basin is 85,362 km² with an irrigated area of approximately 750,000 hm² and over 3 million inhabitants. There are some 360 hydroelectric plants in the basin with an installed capacity of around 4,000 MW and an average annual production of 9,400 GWh.

The Ebro Dam is located at the headwaters and it was conceived as a inter-annual regulation reservoir, its designer (M. Lorenzo Pardo) set its storage capacity equal to one

and a half times the contribution of the river in a normal year, since he was convinced that the Ebro was a radically irregular river and for this reason it should be regulated in its headwaters.

The inter-annual nature of the Ebro Reservoir was something completely innovative then, since it was the first time that this concept was applied in Spain as a technique for managing the water resources of a river basin. Today this concept is universally accepted, as it ensures that the average flow of the river over time can be actually used, but when Lorenzo Pardo designed the Ebro Reservoir (1913-1916), it was a highly opposed, locally (due to the enormous surface that the reservoir occupied, 6,254 hm²) and technically (it was not conceived that for an average annual flow of 350 hm³ a reservoir with a 540 hm³ storage capacity would be needed).

Although in the Ebro basin there are around 120 reservoirs in operation with an approximate capacity of 7,800 hm³, the Ebro



Figure 2. Hydraulic works. [2]

Dam is the third largest in volume within the basin (after Mequinenza and Canelles, 1,530 and 688 hm³, respectively). It is a strategic reservoir, which ensures supply to some of the most important hydraulic infrastructures in the Ebro basin, such as the Aragón Imperial Channel, the Tauste Channel and the Lodosa Channel. It is also the origin of the Ebro-Besaya twin water transfer, which guarantees the water supply of the Cantabria Community.

It is a gravity dam, slightly curved with a radius of 250 m and slopes 0.05 upstream and 0.75 downstream. Its height from its foundation is 34.14 m, and it has a crest length of 215.90 m.

The dam has several discharge facilities (surface spillway, a bottom outlet in the body of the dam, another lateral bottom outlet and four intakes) whose discharge to the river is carried out through six tunnels that converge in a stilling basin.

Manuel Lorenzo Pardo

Manuel Lorenzo Pardo (1881-1953, author in 1916 of the Ebro Dam project) was an illustrious Spanish engineer. He was one of the most important hydraulic engineers in Spain, having made numerous contributions to hydraulic engineering throughout the 20th century: he was a pioneer in considering the creation of inter-annual regulation reservoirs and he was also the ideologist considering river basins as the natural units for water resources management, and advocating the need to create an autonomous body in charge of planning and developing all the hydraulic works in each basin. Based on these ideas, he was the great promoter, founder and first director of the Ebro River Basin Authority (RBA) in 1926, the first RBA worldwide.

Later, in 1932, he was commissioned to prepare a National Hydraulic Works Plan,

which jointly addressed national hydrological problems, based on the different realities of the river basins around the country and taking into account not only hydrological issues, but also geographic, climatic or economic factors. The construction of irrigation works and inter-annual reservoirs were planned, as well as the implementation of water transfers between basins (Tajo-Segura Transfer) to increase fruit and vegetable production on the Mediterranean coast. Lorenzo Pardo urged the creation of an independent entity, the Centre for Hydrographic Studies, to facilitate and accelerate the execution of the studies of the Plan and became its first director. The Centre was established in 1933 (just two years before the foundation of the IAHR) with the aim of directly promoting or carrying out the studies for the most perfect knowledge of Spanish water resources, the application of the most modern techniques for the development of hydraulic uses and to establish general guidelines for water planning. It was incorporated into CEDEX in 1960.

Currently, the Centre has established itself as a fundamental entity for carrying out studies of inland waters at the national level and several activities related to water resources assessment, floods and flooding, water planning, hydraulic infrastructures safety, river hydraulics, water environment and water technology. Its Hydraulics Laboratory has a vast experience in physical model studies of hydraulic structures.

CEDEX studies in the Ebro Dam

Hydraulic study of the spillway

The Ebro Dam spillway was designed with a very complex configuration that has limited its hydraulic capacity since its inception. It has four bays with gates that transfer the flow into two channels. At the end of each channel there is a tunnel. The entrance to these two



Luis Balairón is, since 2006, the Director of the Hydraulics Laboratory of the Centre for Hydrographic Studies of CEDEX in Madrid (Spain). He is PhD Civil Engineer (Polytechnic University of Madrid, specialist in Hydraulics and Energy) and belongs to the Spanish Corps of Civil Engineers. He is also an Associate Professor at the University of Salamanca.



María Isabel Berga, Senior Technical Civil Engineer, is Program Director of the Hydraulics Laboratory of the Centre for Hydrographic Studies of CEDEX in Madrid (Spain). She has participated in many reduced physical models, applied research projects and the development of Codes of Practice and Technical Guides. She currently coordinates the institutional activities of the Centre.

tunnels is hydraulically very inadequate as there is a sudden transition from the channels to the tunnels. In addition, these tunnels have in their upstream reach a 90° change of direction. On the other hand, two intakes of the reservoir discharge 9 m³/s in each tunnel; after the point of discharge the tunnel section is considerably larger.

In addition, the original weir consisted of two straight line segments at an angle to each other, i.e. it did not conform to any standard weir profile at the time of its construction.

A study was undertaken in the Hydraulics Laboratory of CEDEX on a 1/25 physical model to solve these deficiencies (2015). First, it was found that the spillway capacity was currently limited to 40 m³/s for each tunnel. Several actions were studied in the model in order to increase the spillway capacity and improve its hydraulic performance:

- Replacement of the current gates (free discharge over the crest) with new adjustable floodgates.
- Replacement of the weir profile by a Creager profile. The pillars were also modified in order to improve their hydraulic behaviour.
- The model confirmed that the discharge capacity of the spillway was conditioned by the tunnel section, so it was proposed to increase the upstream section of the tunnel and modify the connection with the intakes. The hydraulic behaviour of the proposed solutions was characterized by measuring the pressures in the weir, depths in the channels,



Figure 3. Manuel Lorenzo Pardo (first row, third from right) with the local authorities during the development of the Ebro Dam project. [3]



Figure 4. Channel entrance to the spillway tunnel. Physical model (left) and prototype after the modification (right).

the historical interest of the structure, it was finally decided to keep the original configuration. To correct the inefficiencies in its operation, it was considered essential to carry out a hydraulic study in a physical model (1/40 scale), which was developed in the Hydraulics Laboratory of the Centre for Hydrographic Studies during 2019.

The current operation of the stilling basin was analysed, studying both the independent behaviour of each tunnel and their simultaneous operation, including asymmetric operation.

The model verified that the operation at the exit of the spillway tunnels is generally acceptable, although some inefficiencies were identified (insufficiency of the weir at the exit of the tunnels to stop the flow, irregularities in asymmetric operations, overflows, etc.).

To correct these deficiencies, some measures have been proposed, such as increasing by half a meter the height of the weirs at the end of the bottom outlet tunnels, increasing the walls of the stilling basin at the points where overflows have been observed, increasing the width of some sections or smooth the transitions between the joints that are now 90°. This study has recently been completed and the structure is going to be implemented with the proposed modifications.

Conclusions

The collaboration between CEDEX and the Ebro RBA highlights the importance of the maintenance of hydraulic infrastructures supported by rigorous technical studies. The case study of the Ebro Dam is also representative of the value of the historical heritage of public works in Spain: a dam designed in 1916 by Lorenzo Pardo, one of the most relevant hydraulic engineers, who in 1933 founded the Centre for Hydrographic Studies of CEDEX and where in the 21st Century the necessary adaptations of this dam were studied in physical models in order to continue providing service in the future. It is a veiled tribute to 100 years of the history of hydraulic engineering in Spain, contemporary of the foundation and development of IAHR, an institution closely linked to CEDEX as a host organization of the Association since 2000 when IAHR moved from The Netherlands to Spain. ■

References

- [1] Revista de Obras Públicas. Number 2242. Madrid, September 12, 1918.
[2] *The Ebro Reservoir. Competition for the execution of the hydraulic works.* Ebro RBA. Zaragoza, 1927.

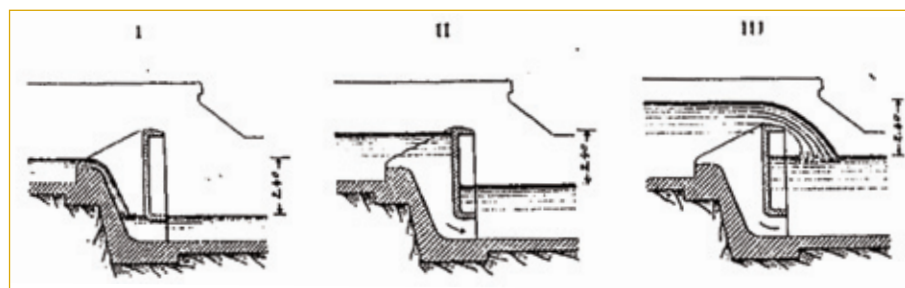

Figure 5. Functioning of the stilling basin structures.^[1]



Figure 6. Physical model of the stilling basin.

analysing the flow behaviour in the tunnels, etc. With the proposed improvements it was possible to increase the capacity of each tunnel to 50 m³/s, reaching 70 m³/s with some occasional functioning, which represented a significant improvement in its operation. Based on the conclusions of the hydraulic study, the Ebro RBA has accepted the proposed modifications of the spillway.

Hydraulic study of the stilling basin

The stilling basin of the Ebro Dam is a truly complex and unique structure where six tunnels from the discharge facilities end.

Energy dissipation of the flow from the different tunnels occurs there through special structures arranged in successive steps. In these structures, part of the flow goes through lower holes and the rest through superficial discharge.

This very unique configuration has caused different hydraulic problems during the operation of the dam. These problems were associated with the turbulence of the flow and the growth of vegetation. In order to solve them it was proposed to replace the stilling basin with a standard design. However, given



39th IAHR
WORLD CONGRESS
From Snow to Sea
4-9 July 2021 GRANADA, SPAIN



39th IAHR WORLD CONGRESS From Snow to Sea (S2S)

iahrworldcongress.org

Motivation

As expressed in IAHR's Strategic Plan for 2020-2023, water is at the centre of major global challenges including climate change, sustainable development, growing population and its needs, food security, income inequality and poverty, limited water resources and their management, and safeguarding biodiversity in many parts of the world. IAHR seeks to play a central role in mobilising the world's collective know-how in state-of-the-art engineering, innovation and research to contribute to dealing with the major global water challenges of our times.

Why "From Snow to Sea"?

The general theme of the Congress "From Snow to Sea (S2S)" highlights IAHR's commitment to the sustainable management of the water cycle and IAHR's contribution towards achieving the Sustainable Development Goals set by the United Nations. Therefore, S2S enhances the innate overlapping and joint work between all the elements that comprise the water cycle. This general theme includes the many water-flow processes associated with ecosystems, the interrelations and interactions of these processes with human water infrastructure. Further, this theme implies collaborative work on

environmental, social and economic levels, taking into account the diverse interests of governmental agencies, companies and people generally. IAHR's World Congress aims to be a platform demonstrating IAHR's major, international role in fulfilling this theme.

Implementation of the General Theme

The International Scientific Committee (<https://iahrworldcongress.org/international-scientific-committee/>) and the Congress Organising Group (<https://iahrworldcongress.org/congress-organising-group/>) of IAHR's 2021 World Congress have elaborated a scientific programme comprising eight focal themes to implement the congress's over-arching or general theme. We have also tried to ensure that the scientific programme includes all the issues, visions and challenges facing IAHR's technical communities.

Eight focal themes can be found in the webpage of the congress: <https://iahrworldcongress.org/themes/>

Miguel Ortega-Sánchez, Chair of the Congress Organising Group
Rob Ettema, Chair of the International Scientific Committee

85

IAHR
85 ANNIVERSARY



CRC Press
Taylor & Francis Group

OUT NOW

Hydraulics of Levee Overtopping

LIN LI, FARSHAD AMINI, YI
PAN, SAIYU YUAN, BORA CETIN

**30% off for
IAHR members**

CLAIM YOUR DISCOUNT CODE
AT MEMBERSHIP@IAHR.ORG

ORDER
YOUR COPY
TODAY!



<https://www.iahr.org/index/books>

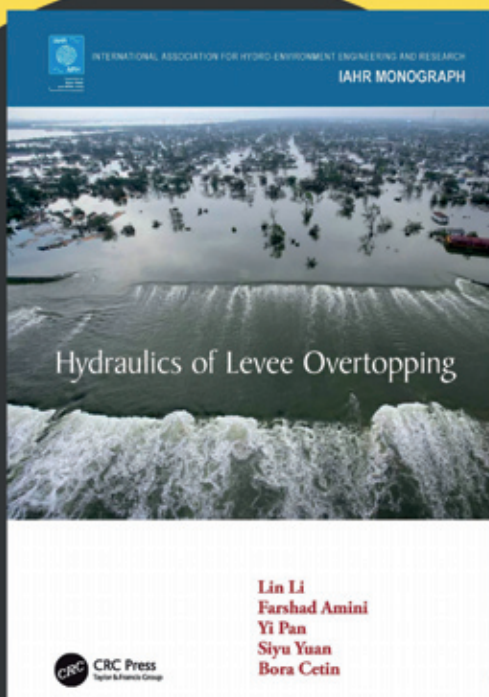



**Prince Sultan Bin Abdulaziz
International Prize for Water**

.....
Recognizing Innovation
.....

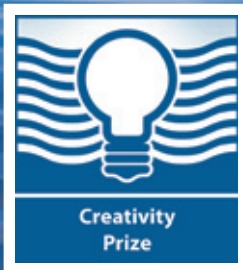

**Creativity
Prize**



**Surface Water
Prize**

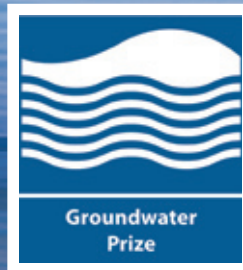

**Groundwater
Prize**

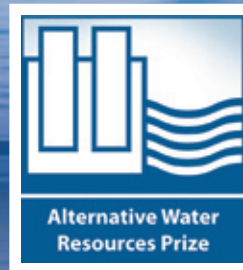

**Alternative Water
Resources Prize**



**Water Management &
Protection Prize**

10th Award (2022)

Invitation for Nominations

**Nominations open online
until 31 December 2021**

www.psipw.org

e-mail: info@psipw.org